

Edition  
2023

# VMG



Voilerie, Sellerie & Découpe laser



Soromap, fabricant français depuis 1970



**SOROMAP**  
Peintures - Vernis

**Peintures  
&  
antifouling**

**Entretien**

**Anodes**



[www.soromap.com](http://www.soromap.com)



Une marque du

# SOMMAIRE / SUMMARY

## P. 04 DÉCOUPE LASER / LASER CUTTING

Caractéristiques générales / Mean features	p. 05
Découpes, Kit voilese / Cutting, Sail kit	p. 06 à 08

## P. 10 VOILERIE, SELLERIE, TISSUS & TOILES / SALMAKING & COVERMAKING, FABRICS & CANVAS

Tissus Dacron / Dacron fabrics	p.12 à 15	SUNWORKER DICKSON	p.47
Tissus Laminés / Laminated fabrics	p.16	Filet de liaison - Grilles / Meshes / Net - Trampoline - End bag	p.49 à 51
Tissus de portant / Downwind sail cloths	p.17	SUNBRELLA Coussins / Cushions in & out	p.52 à 61
Tissus tissés / Woden fabrics	p.18 à 19	STAMSKIN FERRARI	p.62 à 64
Tissus classique / Polyester Classic fabrics UV treated	p.20	VINYLE MORBERN	p.65 à 68
Spi Croisière / Spinnaker fabrics	p.21	BATYLINE FERRARI	p.69 à 75
Tissus Spi - Monofilm / Race spi cloth - Polyan	p.22 à 23	Vaigrage, sous matelas / Coated polyester fabrics, Under mattress	p.76 à 77
Acrylique (SOLACRYL, ORCHESTRA, SUNBRELLA) / Acrylics SOLACRYL, ORCHESTRA, SUNDRELLA	p.24 à 33	Tissus à sac / Bag fabrics	p.78 à 79
Polyester (ODYSSEY, SOFTOUCH, SOLARTEX 300, TOP NOTCH 9) / Polyester (ODYSSEY, SOFTOUCH, SOLARTEX 300, TOP NOTCH 9)	p.34 à 35	Tissus mailles polyester / Polyester mesh	p.79
STAMOID FERRARI	p.36 à 38	PVC cristaux / PVC crystals	p.80 à 81
Toile PVC enduite / PVC coated fabric	p.39 à 41	Sac à voiles / Sail bags	p.82 à 83
SOLTIS FERRARI	p.42 à 48		

## P. 84 ACCESSOIRES VOILERIE | SELLERIE / SALMAKING & COVERMAKING ACCESSORIES

Insigna, Bandes de visualisation, Chiffres & lettres / Insigna, Draft tapes, Numbers & letters	p.86 à 89	Poulies, anneaux à friction / Blocks, friction rings	p.127
Double-face, Colles / Double-sided, Glue	p.90 à 92	Rails & accastillages bimini - capotes / Rails & fittings bimini - hood	p.128 à 129
Bande droit-fil, Galons / Tapes, Braid	p.93 à 94	Sandow - Boucles - Crochet / Bungees - Buckles - Hook	p.130 à 134
Ralingues / Headline	p.95 à 97	Fixations et pressions (LOXX, DOT, TENAX, YKK) / Pulleys (LOXX, DOT, TENAX, YKK)	p.135 à 141
Sangles / Webbing	p.98 à 101	Fermetures YKK, Velcro / YKK Zip, Velcro	p.142 à 145
Fils / Thread	p.102 à 104	Lattes (plates, jonc, profilées...) / Battens (Flat, Rod, profiled...)	p.147 à 148
Cordage (guindant, Nerf de chute, Kitesurf) / Ropes (Leech, Kitesurf)	p.106 à 107	Embouts lattes, boîtiers, tendeurs / Battens, case, adjusters	p.150 à 151
Câble antitorsion / Antitorsion cable	p.108	Tube carbone - Butées de latte / Carbon tube - Batten pocket protectors	p.151 à 152
Coulisseaux - Cardan inox / Slides - Stainless steel toggle	p.109 à 113	Boîtiers, Tendeur de latte, Chariots, Manchons / Case, Batten tension, Carriages, Sleeves	p.153 à 155
Manilles, Mousquetons, Clam cleat / Shackles, Hanks, Clam cleat	p.114 à 118	Chaussette à spi / Spinnaker socks	p.157
Têtières, point d'écoute / Headboard, Clew plate	p.119 à 120	Outils et entretien / Tools and maintenance	p.158 à 164
Plaque point d'écoute / Clew plate	p.120 à 121		
Œillets / Grommets	p.122 à 123		
Triangles, Ferrures, Anneaux, Cosse / Triangle, Fitting, Ring, Thimble	p.124 à 126		

## P. 166 FICHES TECHNIQUES / DATA SHEETS

## P. 176 INDEX / INDEX

## Découpes : Laser, fer à chaud, couteau / Cutting: Laser, hot iron, knife

Equippée d'une machine laser " Lectra Système ", " Bravearm " à froid et d'une machine à découper à chaud, nous vous proposons :

- de la découpe seule sur la base de fichiers fournis par vos soins. (nous découpons n'importe quel tissu existant sur le marché).
- des kits voiles standards incluant dessin, découpe tissu et renfort.
- de gérer pour vous l'approvisionnement ou le stockage des tissus choisis.
- Découpe de rouleaux de tissus.

*/ Equipped with a laser machine "Lectra System" and "Carlson", we offer:*

- cutting only on the basis of data supplied by you (we cut any fabric that exists on the market)*
- standard kit including sails drawing, cutting fabric and reinforcement*
- for you to manage the supply and storage of selected fabrics*

Photos et couleurs de cette rubrique non contractuelles. Côtes et schémas peuvent être modifiés sans avertissement préalable.

*/ Pictures and colors are not contractual. Coasts and patterns can be changed without notice*

## Caractéristiques générales / Mean features

Nos systèmes peuvent recevoir les fichiers de types suivants :  
 .for, .dxf, .dxf aama, .ntv, .nst, .uc, .hpgl, .pdf

/ Our systems can receive the following types of files:  
 .for, .dxf, .dxf aama, .ntv, .nst, .uc, .hpgl, .pdf

Vos fichiers sont éventuellement traités grâce aux programmes :  
 - MIB2000  
 - Contrôle droit fil  
 - Numérotation  
 - Modification, mise à l'échelle, conversion en dxf, ...

Your files are then processed through the programs:  
 - MIB2000  
 - control line  
 - Numbering  
 - Modification, scaling, conversion to dxf

**Fiches de commandes / Order form / pages 168 à 174**

### Tissus / Fabrics

- /// Tissus stock VMG (facturés par VMG) / Fabrics stock VMG (charged by VMG):**  
 - Challenge                      - Sunbrella                      - Morbern  
 - Richard Hayward              - Dickson                        - Odyssey  
 - Tissus VMG                      - Serge Ferrari
- /// Tissus dépôt consigné / Fabrics returnable deposit**  
 - Contender (facturés par Contender) / Charged by Contender
- /// Tissus Dimension Polyant / Fabrics Dimension Polyant**  
 - Commandés par nos soins selon placement (facturés par Dimension Polyant)  
 / Ordered by us according to placement (charged by Dimension Polyant)
- /// Tissus dépôt client / Fabrics deposit client**  
 - Nous pouvons entreposer vos tissus et en gérer le stock  
 / We can store your fabrics and manage the stock

Le numéro des laizes est systématique. Choisir l'option de traçage permet de mieux visualiser : le recouvrement, la position des lattes, ris, ...  
 / Number of panels is systematic. Choosing the drawing option allows a better view of: the recovery, the position of the slats, laugh, ...

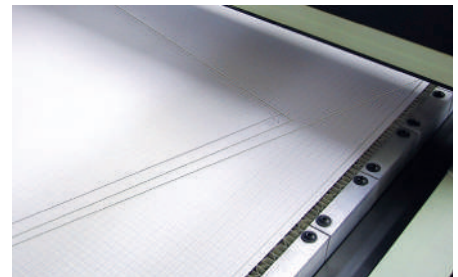

### Forfait

Un forfait sera facturé pour toute prise en charge d'une commande de découpe.  
 / A fee will be charge for any order cutting

860388	Forfait coupe voile inf 10 m <sup>2</sup>
860388D	Forfait coupe voile inf 10 m <sup>2</sup> dessin
860399	Forfait cross cut
860399D	Forfait cross cut avec dessin
860400	Forfait radial
860400D	Forfait radial avec dessin



**ATTENTION**

### Voiles d'ombrages / Shades sails

- /// 860300**                              Découpe voile d'ombrage > = 10 m<sup>2</sup>  
 / Cutting shade sails > = 10 m<sup>2</sup>
- /// 860301**                              Découpe voile d'ombrage < 10 m<sup>2</sup>  
 / Cutting shade sails < 10 m<sup>2</sup>
- /// 860302**                              Forfait dessin voile d'ombrage  
 / Package design shade sails
- /// 860303**                              Kit voile d'ombrage Soltis 92 / m<sup>2</sup>  
 / Shade sail kit Soltis 92 / m<sup>2</sup>



Découpes : Laser, fer à chaud, couteau / Cutting: Laser, hot iron, knife

## Découpes / Cutting

### //// Découpe Seule / Only cut

Fichiers fournis par vos soins. / Files provided by you.

860401	D&T Voiles Crosscut m <sup>2</sup>
860402	D&T Voile Carbone / m <sup>2</sup>
860403	D&T Voiles polyester Orientée / m <sup>2</sup>
860405	D&T Voile Kevlar® / m <sup>2</sup>
860406	D&T Voile Spectra® / m <sup>2</sup>
860407	Découpe seule Spi / m <sup>2</sup>



### //// Dessin et découpe / Drawing and cutting

860401D	D&T Voiles Crosscut m <sup>2</sup> dessin
860402D	D&T Voile Carbone / m <sup>2</sup> dessin
860403D	D&T Voile poly Orientée / m <sup>2</sup> dessin
860405D	D&T Voile Kevlar® / m <sup>2</sup> dessin
860406D	D&T Voile Spectra® / m <sup>2</sup> dessin
860407D	Découpe seule Spi / m <sup>2</sup> dessin

Pour vos commandes de dessin : Afin de limiter les risques d'erreurs ou d'oublis, vous devez remplir nos fiches de commandes.

/ For your drawing orders: To limit the risk of errors or omissions, please complete our order form

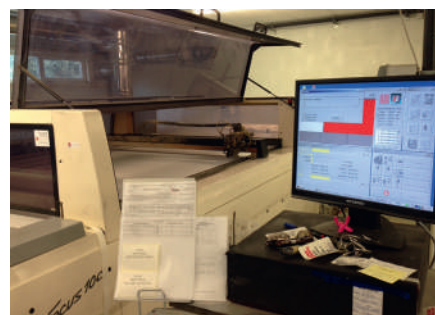

## Kit voiles / Sail kit

Incluant : Dessin, découpe, tissus et renforts / Including: Drawing, cutting, fabric and reinforcement.

### //// Kit cross cut INSHORE

860414	Kit Cross Cut Inshore 4 oz / ml
860414D	Kit Crosscut Inshore 4 oz / ml Dessin
860415	Kit Crosscut Inshore 5 oz / ml
860415D	Kit Crosscut Inshore 5 oz / ml Dessin
860416	Kit Crosscut Inshore 6 oz / ml
860416C	Kit Crosscut Inshore Color 6 oz / ml
860416D	Kit Crosscut Inshore 6 oz / ml Dessin
860416DC	Kit Crosscut Inshore Color 6 oz / ml Dessin
860417	Kit Crosscut Inshore 7 oz / ml
860417D	Kit Crosscut Inshore 7 oz / ml Dessin
860418	Kit Crosscut Inshore 8 oz / ml
860418D	Kit Crosscut Inshore 8 oz / ml Dessin
860419	Kit Crosscut Inshore 9 oz / ml
860419D	Kit Crosscut Inshore 9 oz / ml Dessin
860420	Kit Crosscut Inshore 10 oz / ml
860420D	Kit Crosscut Inshore 10 oz / ml Dessin
860421	Kit Crosscut Inshore 11 oz / ml
860421D	Kit Crosscut Inshore 11 oz / ml Dessin



### //// Kit cross cut OFFSHORE

864906	Kit Crosscut Offshore 6 oz / ml
864906d	Kit Crosscut Offshore 6 oz / ml Dessin
864907	Kit Crosscut Offshore 7 oz / ml
864907d	Kit Crosscut Offshore 7 oz / ml Dessin
864908	Kit Crosscut Offshore 8 oz / ml
864908d	Kit Crosscut Offshore 8 oz / ml Dessin
864909	Kit Crosscut Offshore 9 oz / ml
864909d	Kit Crosscut Offshore 9 oz / ml Dessin
864910	Kit Crosscut Offshore 10 oz / ml
864910d	Kit Crosscut Offshore 10 oz / ml Dessin
864911	Kit Crosscut Offshore 11 oz / ml
864911d	Kit Crosscut Offshore 11 oz / ml Dessin



## Kit voiles / Sail kit

### //// Kit orientés / Oriented sail kit

863405	Kit Orienté Pro Radial 5.1 / ml
863405D	Kit Orienté Pro Radial 5.1 Dessin
863406	Kit Orienté Pro Radial 6.1
863406D	Kit Orienté Pro Radial 6.1 Dessin
863407	Kit Orienté Pro Radial 7.1
863407D	Kit Orienté Pro Radial 7.1 Dessin
863408	Kit Orienté Pro Radial 8.1
863408D	Kit Orienté Pro Radial 8.1 Dessin
863409	Kit Orienté Pro Radial 9.1
863409D	Kit Orienté Pro Radial 9.1 Dessin
863410	Kit Orienté Pro Radial 10.1 / ml
863410D	Kit Orienté Pro Radial 10.1 dessin / ml

862404	Kit Orienté Warp Drive 4.11 / ml
862404D	Kit Orienté Warp Drive 4.11 Dessin
862405	Kit Orienté Warp Drive 5.11
862405D	Kit Orienté Warp Drive 5.11 Dessin
862406	Kit Orienté Warp Drive 6.11
862406D	Kit Orienté Warp Drive 6.11 Dessin
862407	Kit Orienté Warp Drive 7.11
862407D	Kit Orienté Warp Drive 7.11 Dessin
862408	Kit Orienté Warp Drive 8.11
862408D	Kit Orienté Warp Drive 8.11 Dessin
862409	Kit Orienté Warp Drive 9.11
862409D	Kit Orienté Warp Drive 9.11 Dessin
862410	Kit Orienté Warp Drive 10.11
862410D	Kit Orienté Warp Drive 10.11 Dessin
862411	Kit Orienté Warp Drive 11.11
862411D	Kit Orienté Warp Drive 11.11 Dessin
862412	Kit Orienté Warp Drive 12.11
862412D	Kit Orienté Warp Drive 12.11 Dessin
862413	Kit Orienté Warp Drive 13.11
862413D	Kit Orienté Warp Drive 13.11 Dessin

864912	Kitcode Tec 55 / ml
864912D	Kitcode Tec 55 Avec Dessin
864913	Kitcode Tec 95
864913D	Kitcode Tec 95 Avec Dessin
864914	Kitcode Tec 135
864914D	Kitcode Tec 135 Avec Dessin



Découpes : Laser, fer à chaud, couteau / Cutting: Laser, hot iron, knife

## Kit voiles / Sail kit

### //// Kit Laminés / Laminated kits

864915	Kit Baltic Code Zéro 4A ml
864915D	Kit Baltic Code Zero 4A ml/Dessin
864916	Kit Baltic Code Zéro 6A ml
864916D	Kit Baltic Code Zero 6A ml/ Dessin
864917	Kit Baltic Code Zéro 6P ml
864917D	Kit Baltic Code Zero 6P ml/Dessin
864918	Kit Baltic Code Zéro 8A ml
864918D	Kit Baltic Code Zero 8A ml/ Dessin

864919	Kit XRP 6 Sport
864919D	Kit XRP 6 Sport avec Dessin
864920	Kit XRP 9 Sport
864920D	Kit XRP 9 Sport avec Dessin
864921	Kit XRP 13 Sport
864921D	Kit XRP 13 Sport avec Dessin
864922	Kit XRP 18 Sport
864922D	Kit XRP 18 Sport avec Dessin

864923	Kit XRP 6 Cruise
864923D	Kit XRP 6 Cruise avec Dessin
864924	Kit XRP 9 Cruise
864924D	Kit XRP 9 Cruise avec Dessin
864925	Kit XRP 13 Cruise
864925D	Kit XRP 13 Cruise avec Dessin
864926	Kit XRP 18 Cruise
864926D	Kit XRP 18 Cruise avec Dessin

864927	Kit Cl 6 P ml
864927D	Kit Cl 6 P avec Dessin / ml
864928	Kit Cl12 P ml
864928D	Kit Cl12 P avec Dessin / ml
864929	Kit Cl18 P ml
864929D	Kit Cl18 P avec Dessin / ml

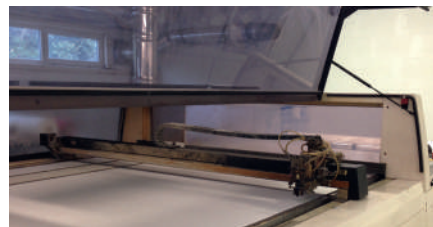

### //// Kit Spi / Spi kit

860424	Kit Spi Std (45-70 gr) / ml
860424D	Kit Spi Std (45-70 gr) / ml Dessin
860426	Kit Spi Lourd (80 gr / ml)
860426D	Kit Spi Lourd (80 gr / ml) Dessin
860427	Kit Spi Premium (Elite / Airx)
860427D	Kit Spi Premium (Elite / Airx) Dessin
860428	Kit Spi Lourd (150 gr / ml)
860428D	Kit Spi Lourd (150 gr / ml) Dessin

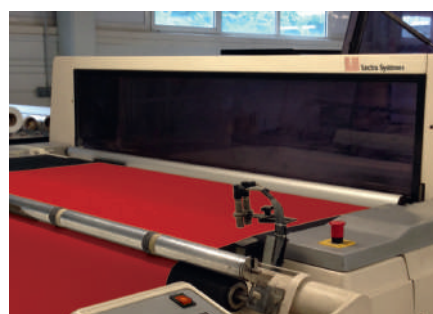









# Tissus / *Sailcloth and Fabrics*

Photos et couleurs de cette rubrique non contractuelles. Côtes et schémas peuvent être modifiés sans avertissement préalable.  
*/ Pictures and colors are not contractual. Coasts and patterns can be changed without notice*

## Tissus Dacron / Dacron fabrics



### NEWPORT

Tissus Premium - UV +, rouleau de 45,72 ml ou 100,58 ml - largeur 137 cm  
/ Premium Fabrics - UV+, roll of 50 yards or 110 yards - width 137 cm

Notre ligne Newport est une gamme complète de tissu à voiles Polyester déclinés en trois principaux types de constructions : All Purpose, Low Aspect et Pro Radial. Cette gamme est produite en utilisant la meilleure fibre Polyester pour de toile à voile disponible : la fibre 104. Cette gamme de tissu combine toute la technologie R&D acquise par Challenge Sailcloth lors du développement des gammes Marblehead, Warp-Drive et High Mass Fiber Weaves / Our Newport line is a complete line of polyester sailcloth in three main construction types: All Purpose, Low Aspect and Pro Radial. This line is produced using the best Polyester sailcloth fiber available: 104 fiber. This range of fabrics combines all the R&D technology acquired by Challenge Sailcloth during the development of the Marblehead, Warp-Drive and High Mass Fiber Weaves ranges

#### NEWPORT ALL PURPOSE

Tissu dédié à la fabrication de voiles Cross Cut / Sailcloth for cross cut sails

Réf.	Réf. Challenge	Tissu*	Trame**
864135	D5.45	5.45 Newport AP	200 x 350
864136	D6.45	6.45 Newport AP	220 x 440
864137	D7.45	7.45 Newport AP	275 x 500
864138	D7.95	7.95 Newport AP	275 x 750
864139-1	D8.45	8.45 Newport AP	350 x 840
864139	D8.95	8.95 Newport AP	350 x 840
864140	D9.95	9.95 Newport AP	350 x 1000
864141	D10.95	12.95 Newport AP	440 x 1300

#### NEWPORT LOW ASPECT

Tissu pour voiles Cross Cut à ration bas / Sailcloth for cross cut sails

Réf.	Réf. Challenge	Tissu*	Trame**
864231	D4.93	4.93 Newport LA	150 x 250
864233	D5.53	5.53 Newport LA	250 x 300
864237	D6.53	6.53 Newport LA	250 x 370
864238	D7.03	7.03 Newport LA	250 x 420
864240	D8.03	8.03 Newport LA	300 x 500
864246	D9.03	9.03 Newport LA	300 x 700
864248	D10.53	11.93 Newport LA	350 x 840

#### NEWPORT PRO RADIAL

Tissu pour voiles Croisière en coupe orientée / Cruising Sailcloth for Radial sail type

Réf.	Réf. Challenge	Tissu*	Trame**
864502	D5.1	5.1 Newport Pro Radial	150 x 250
864504	D6.1	6.1 Newport Pro Radial	250 x 350
864505	D7.1	7.1 Newport Pro Radial	350 x 440
864506	D8.1	8.1 Newport Pro Radial	440 x 520
864507	D9.1	9.1 Newport Pro Radial	500 x 570
864498	D10.1	10.1 Newport Pro Radial	600 x 840

#### NEWPORT PRO RADIAL BLACK

Réf.	Réf. Challenge	Tissu*	Trame**
864504BK	D6.1	6.1 Newport Pro Radial Black/Grey	250 x 350
864505BK	D7.1	7.1 Newport Pro Radial Black/Grey	350 x 440
864506BK	D8.1	8.1 Newport Pro Radial Black/Grey	440 x 520
864507BK	D9.1	9.1 Newport Pro Radial Black/Grey	500 x 570
864498BK	D10.1	10.1 Newport Pro Radial Black/Grey	600 x 840



\*Yarn Denier - \*\*Description

## Tissus Dacron / Dacron fabrics

### NEWPORT CLASSIC



Notre ligne de tissu Newport Classic utilise les mêmes fils et constructions que nos autres gammes de Polyester tissés. Les couleurs Tanbark et Cream sont obtenues à l'aide d'un processus de teinture en autoclave sous haute pression / Our Newport Classic fabric line uses the same yarns and constructions as our other woven polyester lines. Designed specifically for classic yachts, the Tanbark and Cream colors are obtained through a high pressure autoclave dyeing process.

Réf.	Réf. Challenge	Largeur	Tissu*	Trame**
864330	DT/DC3.8	1,5	Cream	150 x 250
864330T			Tanbark	
864331	DT/DC5.45	1,37	Cream	250 x 300
864331T			Tanbark	
864332	DT/DC6.45	1,37	Cream	250 x 400
864332T			Tanbark	
864333	DT/DC7.88	1,37	Cream	500 x 650
864333T			Tanbark	
864334	DT/DC8.88	1,37	Cream	500 x 750
864334T			Tanbark	
864335	DT/DC9.88	1,37	Cream	500 x 840
864335T			Tanbark	

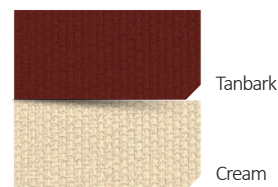

### NEWPORT COLOR

Challenge est le leader mondial des tissus à voile teints. Nos constructions utilisent des fils haute ténacité ainsi que la technologie « High Mass Fiber ». Le processus de teinture en autoclave à haute pression produit des couleurs vives et durables. Les couleurs personnalisées peuvent être assorties aux nuances Pantone à partir de 1000 yards / Challenge is the world leader in dyed sailcloth. Our constructions use high tenacity yarns and High Mass Fiber technology. The high pressure autoclave dyeing process produces vivid and durable colors. Custom colors can be matched to Pantone shades from 1000 yards

Réf.	Réf. Challenge	Largeur	Tissu*	Trame**
864320	D3.8	1,5	3.8 Oz. BLANC	150 x 250
864321	D3.8	1,5	3.8 Oz. COULEUR	150 x 250
864322	D6.03	1,5	6.03 Oz. BLANC	250 x 400
864323	D6.03	1,5	6.03 Oz. COULEUR	250 x 400
971395	D9.88SO	1,37	9 Oz. Storm Orange	500 x 840
971430	D10.88SO	1,37	10 Oz. Storm Orange	500 x 1000



\*Yarn Denier - \*\*Description

## Tissus Dacron / Dacron fabrics



### MARBLEHEAD

Tissus Premium - UV +, rouleau de 45,72 ml - largeur 137 cm

/ Premium Fabrics - UV+, roll of 50 yards - width 137 cm

### MARBLEHEAD RECYCLED

Marblehead REC est le premier tissu à voile au monde fabriqué à partir de fibres entièrement recyclées. Après une recherche approfondie de matériaux à travers le monde et de nombreux tests, Challenge a pu trouver un polyester recyclé qui a les mêmes propriétés que la fibre vierge, ce qui n'était pas possible dans le passé. Notre Marblehead REC utilise la technologie, d'« interlocking » précédemment développée pour cette gamme / Marblehead REC is the world's first sailcloth made from 100% recycled fiber. After an extensive search. Materials worldwide and extensive testing, Challenge was able to find a recycled polyester that has the same properties as virgin fiber. We were able to find a recycled polyester that has the properties of virgin fiber, which was not possible in the past. Our Marblehead REC uses the "interlocking" technology previously developed for this line. Our REC Marblehead uses the "interlocking" technology previously developed for this line.

Réf.	Réf. Challenge
864260-6	MARBLEHEAD Recycled 6.47
864260-7	MARBLEHEAD Recycled 7.47
864260-8	MARBLEHEAD Recycled 8.47
864260-9	MARBLEHEAD Recycled 9.47

### MARBLEHEAD AP

Au fur et à mesure que la conception des bateaux a évolué et que les plates-formes se sont modernisées, il est devenu évident qu'un tissage AP plus équilibré conviendrait mieux aux bateaux et aux applications de croisière d'aujourd'hui. Notre Marblehead AP est construit pour répondre à ce type de bateaux tout en conservant la même technologie et la même philosophie que nos matériaux Marblehead LA et HA / As boat design has evolved and platforms have modernized, it has become apparent that a more balanced AP weave would be better suited to today's cruising boats and applications. Our Marblehead AP is built to meet these types of boats while maintaining the same technology and philosophy as our Marblehead LA and HA materials

Réf.	Réf. Challenge
864261-5	MARBLEHEAD 5.42
864261-6	MARBLEHEAD 6.42
864261-7	MARBLEHEAD 7.42
864261-8	MARBLEHEAD 8.42
864261-9	MARBLEHEAD 9.42
864261-10	MARBLEHEAD 10.42



## Tissus Dacron / Dacron fabrics



### WARP DRIVE

Les tissus de la gamme Warp-Drive sont le meilleur choix pour les marins qui souhaitent bénéficier de la performance d'un laminé, tout en conservant la durabilité d'un tissé. Les styles Warp Drive ont une résistance très élevée du chemin de charge de la chaîne. Contrairement à un laminés, ils ne sont pas sujet à la moisissure ni au délaminage / *Warp-Drive fabrics are the best choice for sailors who want the performance of a laminate, while maintaining the durability of a woven fabric. Warp-Drive styles have very high Warp load path strength but unlike. Unlike a laminate, they are not subject to mildew or delamination*

Réf.	Réf. Challenge	Largeur	Tissu*	Application***
864630	D4.11WD	1,37	4.11 Warp-Drive	RACE
864631	D5.11WD	1,37	5.11 Warp-Drive	RACE
864632	D6.11WD	1,37	6.11 Warp-Drive	RACE
864634	D8.11WD	1,37	8.11 Warp-Drive	RACE
864635	D10.11WD	1,37	10.11 Warp-Drive	RACE
864636	D12.11WD	1,37	12.11 Warp-Drive	RACE
864633	D7.11WDC	1,37	7.11 Warp-Drive	CRUISE
864638	D9.11WDC	1,37	9.11 Warp-Drive	CRUISE
864639	D11.11WDC	1,37	11.11 Warp-Drive	CRUISE
864637	D13.11WDC	1,37	13.11 Warp-Drive	CRUISE

### FASTNET

#### Leading Offshore & Voyage Sailcloth

Les Fastnet sont les dacrons les plus durable, grâce à la technologie " High Mass Fiber Weave " qui protège les fils de trame dans le tressage de gros fils de chaîne / *Fastnet are the most durable dacrons, due to the "High Mass Fiber Weave" technology which protects the weft threads in the braiding of large warp threads*

#### FASTNET

Notre gamme Fastnet est une gamme de tissu à voile extrêmement durable de par sa construction unique. Cette ligne est un développement de la célèbre gamme High Mass Fiber Weaves fruit de 15 ans de développement. Les tissus Fastnet combine toute la technologie et les enseignements tirés des six dernières Clipper Around the World / *Our Fastnet line is a line of sailcloth that is extremely durable due to its unique construction. This line is a development of the famous High Mass Fiber Weaves line, the result of 15 years of development. Fastnet fabrics combine all the technology and lessons learned from the last six Clipper Around the World*

Réf.	Réf. Challenge	Largeur	Tissu*	Trame**
864640	D6.68	1,37	6.68 Fastnet	250 x 400
864641	D7.38	1,37	7.38 Fastnet	300 x 500
864642	D7.88	1,37	7.88 Fastnet	500 x 650
864643	D8.88	1,37	8.88 Fastnet	500 x 750
864644	D9.88	1,37	9.88 Fastnet	500 x 840
864645	D10.88	1,37	10.88 Fastnet	500 x 1000
864646	D11.88	1,37	11.88 Fastnet	500 X 1300

#### FASTNET BLACK

Réf.	Réf. Challenge	Largeur	Tissu*	Trame**
864642B	D7.88BK	1,37	7.88 Fastnet	500 x 650
864643B	D8.88BK	1,37	8.88 Fastnet	500 x 750
864644B	D9.88BK	1,37	9.88 Fastnet	500 x 840
864645B	D10.88BK	1,37	10.88 Fastnet	500 x 1000



\*Yarn Denier - \*\*Description - \*\*\* Purpose

## Tissus Laminés / Laminated fabrics



### //// XRP SPORT

Ces laminés Polyester sont un excellent choix pour les classes qui limitent l'utilisation de fibres exotiques. Les laminés de la gamme XRP possède des rapports résistance/poids élevés. Ils utilisent une technologie d'insert en chaines sans scrims ceci pour réduire le poids et améliorer la capacité de charge sous certains angles. Laize : 150 cm / *These polyester laminates are an excellent choice for classes that limit the use of exotic fibers. XRP laminates have high strength to weight ratios. They use a scrimless chain insert technology to reduce weight and improve load capacity at certain angles. Laize: 150 cm*

Réf.	Warp	60°/0,75"	SMoz/gsm	Désignation
864750	6000	3000	3,04 / 130	XRP Sport 6
864751	9000	3000	3,74 / 160	XRP Sport 9
864752	13000	3000	4,44 / 190	XRP Sport 13
864753	18000	3000	5,14 / 220	XRP Sport 18

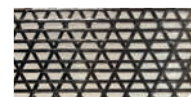

XRP Sport

### //// XRP CL

La gamme XRP CL reprend les constructions du XRP avec en extérieur 2 taffetas Polyester. Destinée aux voiles de type " Croisière - Performance " en coupe orientée. Laize : 150 cm / *The XRP CL range uses the constructions of XRP with two Polyester taffetas on the outside. Intended for "Cruising - Performance" type sails in oriented cut. Laize: 150 cm*

Réf.	Warp	60°/0,75"	SMoz/gsm	Désignation
864750C	6000	3000	6,21 / 266	XRP Cruise 6
864751C	9000	3000	6,51 / 279	XRP Cruise 9
864752C	13000	3000	8,17 / 350	XRP Cruise 13
864753C	18000	3000	9,39 / 402	XRP Cruise 18



XRP CL

### //// PALMA-TEC

Cette gamme de laminés de croisière utilisent des inserts Polyester/UPE de couleur noir en chaine pour des performances et une efficacité optimale. Ce complexe est pris en sandwich entre deux taffetas souple et résistants qui possède une pouvoir adhésif exceptionnelle gage d'une excellente. Laize : 150 cm / *These modern cruise laminates use all inlaid fiber without scrims for highest performance and efficiency. Sandwiched between taffetas, they are soft and strong with tremendous lamination adhesion for excellent durability. Laize: 150 cm*

Réf.	Warp	60°/0,75"	SMoz/gsm	Désignation
864806	6000	1000	6,21 / 266	Palma-Tec 6
864809	9000	1000	6,51 / 279	Palma-Tec 9
864813	12000	1000	8,17 / 350	Palma-Tec 13
864818	18000	1000	9,39 / 402	Palma-Tec 18
864824	24000	1000	10,09 / 432	Palma- Tec 24



PALMA-TEC





## Tissus de portant / Downwind sail cloths

# CHALLENGE AILCLOTH

### //// BALTIC

Les laminés de la gamme Baltic Code Zéro sont des laminés performants produits pour la fabrication de code zéro. La gamme Baltic a été conçue avec un taffetas léger sur une face, des inserts de fibres Aramide et UPE en chaîne ainsi que des fibres orientées à 22°. 4 styles sont disponibles / The Baltic Code Zero range of laminates are high performance laminates produced for code zero manufacturing. The Baltic line was designed with a lightweight taffeta on one side, Aramid and UPE fiber inserts in warp and 22° oriented fibers. 4 styles are available. Laize: 150 cm

Réf.	Warp	22°/1,5"	SMoz/gsm	Désignation
864770	6000	1000	3,01 / 129	Baltic CZ Polyester 6
864760	4000	1000	2,57 / 110	Baltic CZ Aramid 4
864761	6000	1000	2,76 / 118	Baltic CZ Aramid 6
864762	8000	1000	2,99 / 128	Baltic CZ Aramid 8

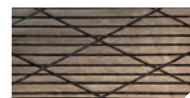

Baltic

### //// CODE-TEC

Challenge a développé cette nouvelle gamme de tissus unique pour répondre aux exigences de performance de ces nouvelles générations de voiles de reaching. Notre gamme Code-Tec utilise des fibres Polyester haute ténacité ainsi qu'une technologie de coating exclusive afin de fabriquer un tissu à voile haute performance et durable offrant une faible élasticité, une résistance élevée à la déchirure et la capacité de résister à des enroulements répétés / Challenge has developed this unique new range of fabrics to meet the performance requirements of these new generations of reaching sails. Our Code-Tec range uses high tenacity polyester fibers and a proprietary coating technology to produce a durable, high performance sailcloth with low stretch, high tear strength and the ability to withstand repeated furling.

Réf.	SMoz/gsm	Désignation
864850	1,2 / 52	Code-Tec 55p
864851	1,9 / 81	Code-Tec 95p
864852	3,1 / 132	Code-Tec 135p



Blanc



Pantone 7540C

### //// SUN-TEC

Le Sun-Tec est un nouveau concept de bande anti-UV. Ce tissu utilise des fibres Polyester haute ténacité ainsi qu'une formule de coating UV innovante. D'un poids de 133 grammes par mètre carré, le Sun-Tec est extrêmement léger par rapport aux autres bandes anti-uv du marché, il possède néanmoins une très bonne résistance aux UV et à l'abrasion. Largeur laize 150 cm, Longueur rouleau 45 m. / Sun-Tec is a new concept in UV protection tape. This fabric uses high tenacity polyester fibers and an innovative UV coating formula. Weighing only 133 grams per square meter, Sun-Tec is extremely light compared to other UV tapes on the market, yet it has very good UV and abrasion resistance. Width 150 cm, roll length: 45 m

Réf.	Désignation
864860	Sun-Tec Blanc / White Sun-Tec
864861	Sun-Tec Blanc Adhésivé / PSA White Sun-Tec



Sun-Tec

### //// CL PALMA

Notre nouvelle gamme de laminés de croisière Palma utilise un mix de fibre Polyester et UPE encapsulé entre des taffetas Polyester. Spécialement conçus pour les bateaux de croisière modernes et des marins soucieux de la performance de leur voiles, l'apport de fibres UPE en chaîne amène un gain en matière de stabilité sous charge du tissu. Parce que les croisiéristes aiment aussi aller vite sur l'eau / Our new range of Palma cruising laminates uses a mix of Polyester and UPE fibers encapsulated between Polyester taffeta. Specially designed for modern cruising boats and sailors concerned about the performance of their sails, the addition of UPE fibers in the warp brings a gain in stability under load of the fabric. Because cruisers also like to go fast on the water

Réf.	Warp	22°/1,5"	SMoz/gsm	Désignation
864780	6000	1000	5,86 / 251	CL18P Palma UPE
864781	9000	1000	6,47 / 277	CL24P Palma UPE
864782	12000	1000	7,28 / 312	CL12P Palma UPE



CL Palma

## Tissus tissés / Woven Fabrics



Tissu Premium, avec traitement UV + pour voiles cross cut. Largeur 140 cm

Premium fabric, with UV + treatment for cross cut sails. Width 140 cm

Réf.	gsm/sMoz	Désignation
FWP042500	170 / 3,9	SPX 425 Natural
FWP052500	223 / 5,2	SPX 525 Natural
FWP062500	278 / 6,5	SPX 625 Natural
FWP072500	325 / 7,6	SPX 725 Natural
FWP075500H	364 / 8,5	SPX 755 Strong Fill
FWP082500	415 / 9,7	SPX 825 Natural
FWP092500	451 / 10,6	SPX 925 Natural
FWP102500	480 / 11,2	SPX 1025 - 137 cm
FWP115500	-	SPX 1155 Strong Fill - 137 cm

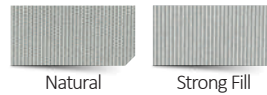

## SPX CLASSIC

Tissu Premium, avec traitement UV + pour voiles vieux gréement. Largeur 140 cm

Premium fabric, with UV + treatment for old rig sails. Width 140 cm

Réf.	gsm/sMoz	Désignation
FWP052521	223 / 5,2	SPX 525 Classic Tan
FWP062503	278 / 6,5	SPX 625 Classic Cream
FWP062521	278 / 6,5	SPX 625 Classic Tan
FWP072503	325 / 7,6	SPX 725 Classic Cream
FWP072521	325 / 7,6	SPX 725 Classic Tan
FWP082503	364 / 8,5	SPX 825 Classic Cream
FWP082521	364 / 8,5	SPX 825 Classic Tan
FWP092503	415 / 9,7	SPX 925 Classic Cream
FWP092521	415 / 9,7	SPX 925 Classic Tan

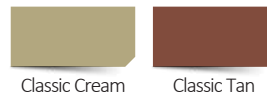

## SPX BLACK

Tissu Premium avec traitement UV + et traitement spécial coloris NOIR. Largeur 140 cm

Premium fabric with UV + treatment and special BLACK color treatment. Width 140 cm

Réf.	gsm/sMoz	Désignation
FWP052599	223 / 5,2	SPX 525 Noir
FWP062599	278 / 6,5	SPX 625 Noir
FWP082599	364 / 8,5	SPX 825 Black
FWP092599	415 / 9,7	SPX 925 Black



## SPX STORM

Tissu Premium Orange pour répondre aux règles de sécurité internationale. Largeur 140 cm

Orange Premium fabric to meet international safety regulations. Width 140 cm

Réf.	Désignation
FWP102520	SPX 1025 Storm Orange
FWP082520	SPX 825 Storm Orange



## Tissus tissés / Woven Fabrics

### SPX COLORS

Tissu Premium avec traitement UV + pour voiles en couleur. Largeur 140 cm

Premium fabric with UV + treatment for colored sails. Width 140 cm

Réf.	gsm/sMoz	Désignation	Réf.	gsm/sMoz	Désignation
FWP042510	170 / 3,9	SPX 425 Rouge	FWP062510	278 / 6,5	SPX 625 Rouge
FWP042550	170 / 3,9	SPX 425 Vert	FWP062522	278 / 6,5	SPX 625 Orange
FWP042561	170 / 3,9	SPX 425 Dark Blue	FWP062530	278 / 6,5	SPX 625 Jaune
FWP042592	170 / 3,9	SPX 425 Gris	FWP062555	278 / 6,5	SPX 625 Vert Clair
FWP042599	170 / 3,9	SPX 425 Noir	FWP062563	278 / 6,5	SPX 625 Bleu Glacier
FWP062561	278 / 6,5	SPX 625 Bleu Marine	FWP062513	278 / 6,5	SPX 625 Rose

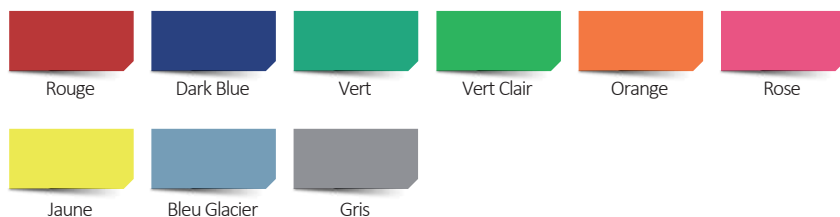

### HSX - P

Tissu Premium avec construction ripstop pour des voiles très résistante dans le temps. Largeur 140 cm

Premium fabric with ripstop construction for very resistant curtains over time. Width 140 cm

Réf.	gsm/sMoz	Désignation
FWP062600	266 / 6,32	HSX-P 626
FWP072600	334 / 7,80	HSX-P 726
FWP082600	360 / 8,41	HSX-P 826
FWP092600	404 / 9,44	HSX-P 926

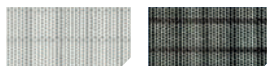

### HSX - V

Tissu hybride Premium qui incorpore la fibre Vectran à très faible allongement. Tenue & durée de vie exceptionnelle. Adapté aux coupes radiales ou cross cut. Largeur 140 cm

Premium hybrid fabric that incorporates very low stretch Vectran fiber. Exceptional durability & durability. Suitable for radial or cross cuts. Width 140 cm

Réf.	gsm/sMoz	Désignation
FWP072700F	328 / 7,7	HSX VECTRAN® 727
FWP082700F	371 / 8,7	HSX VECTRAN® 827

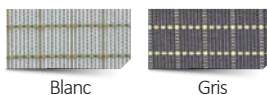

## Tissus classique / Polyester Classic fabrics UV treated

### ////// Clipper Canvas traité anti UV / UV resistant canvas clipper

Tissu très souple (sans enduction) spécialement étudié pour les voiles de vieux gréements. Tissage 1 fil (CANVAS), traitement anti UV et imputrescible. Couleurs disponibles : Champagne et Tan léger. **Vendu au mètre**  
 / Very soft cloth (without coating) specially designed for the sails of traditional ships. Weaving a thread (Canvas), anti UV and rot.  
 Colours available: Champagne and light tan. **Sold by the meter**



Réf.	Poids (g/m <sup>2</sup> )	Smoz	Construction	Largeur	Couleur
901310	310	7.2	Canvas	150	Champagne
901375	473	11.0	Canvas	60	Champagne
901510	550	12.8	Canvas	60	Champagne
901730	632	14.7	Canvas	60	Champagne
901731	750	17.7	Canvas	60	Champagne
911310	310	7.2	Canvas	150	Tan
911375	473	11.0	Canvas	60	Tan
911510	550	12.8	Canvas	60	Tan
911730	632	14.7	Canvas	60	Tan
911731	750	17.7	Canvas	60	Tan



## Spi Croisière / Spinnaker fabrics ❗



### ////// Tissus Nylon " FIBERMAX " imprégné / Nylon fabric "FIBERMAX" impregnated

FIBERMAX nouvelle génération, spi nylon avec tissage serré pour une meilleure longévité et tenue des couleurs  
 / FIBERMAX new generation, nylon spinnaker with tight weave for better longevity and color fastness

#### /// Fibertext Nylon 0.75 oz FS44

Couleurs : Blanc, rouge, bleu foncé, bleu marine, bleu clair, jaune, vert, or, orange, noir, violet, gris, rose fluo, framboise fluo, vert fluo, jaune fluo.  
 Largeur : 150 cm. Rouleau de 137,16 ml  
 / Colours: White, red, dark blue, marine blue, clear blue, yellow, green, gold, orange, black, purple, grey, fluo pink, fluo raspberry, fluo green, fluo yellow  
 Width: 150 cm. Roll of 150 yards

Black	Dark Blue	Fluo Green	Fluo Orange	Fluo Raspberry	Fluo Yellow	Gold	Light Blue	Orange	Ocean Blue
B	DB	FG	FO	FR	FY	G	LB	O	OB

#### FIBERMAX 44

##### 864603 Blanc

864604 Couleur + Lettres pour préciser la couleur ( tableau ci-dessus)

Ex : 864604LB pour Fibermax 44 Light Blue

#### FIBERMAX 64

##### 864606 Blanc

864607 Couleur + Lettres pour préciser la couleur ( tableau ci-dessus)

Ex : 864607B pour Fibermax 64 Black

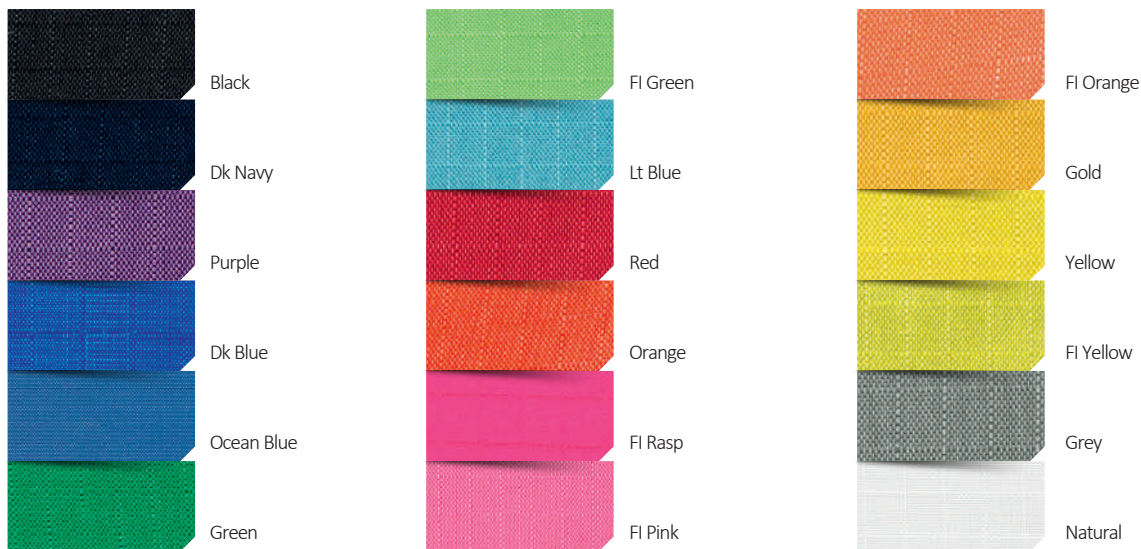

#### /// 2.2 oz Tissu Nylon Tempête FS94

Couleurs : Blanc, rouge, bleu foncé.  
 Largeur : 150 cm. Rouleau de 50 m.  
 / Colours: White, dark blue. Width: 150 cm. Roll of 50 m

864610M Fibermax 94 Dark Blue

864610W Fibermax 94 White

#### /// 3.4 oz Whithbread Nylon FS144

Couleur : Blanc. Largeur : 150 cm. Rouleau de 50 m.  
 / Colour: White. Width: 150 cm. Roll of 50 m

864612 Fibermax 144 Natural

#### /// 4.4 oz FS184

Couleur : Blanc. Largeur : 150 cm. Rouleau de 50 m.  
 / Colour: White. Width: 150 cm. Roll of 50 m

864613 Fibermax 184 Natural



## Tissus spi / Race spi cloth

### AIRX SPI REGATE



Spi régata, qualité Grand Prix avec des performances éprouvées en course. Fils de nylon 6.6 haute tenacité & construction haute densité offre un spi léger & performant. Tissage ripstop double pour une exceptionnelle résistance à la déchirure lors du maniement en course. Excellente imperméabilité. Idéal pour spis asymétriques / Grand Prix quality regatta spinnaker with race proven performance. High tenacity 6.6 nylon yarns in a high density construction delivering light sails in higher wind ranges. Double ripstop weave delivers exceptional burst and tear strength and reduces damage from rig contact and handling. Excellent waterproofing. Ideal for asymmetric spinnakers

	AIRX 400	AIRX 500	AIRX 600	AIRX 650	AIRX 700	AIRX 800	AIRX 900
Construction	F5151A00Y	F5151A15Y	F5151A10Y	X	X	X	X
Chaîne/Trame	20 x 20	30 x 20	30 x 30	30 x 30	30 x 30	45 x 45	70 x 70
Laize (mm)	1520	1520	1520	1520	1520	1520	1520
Poids (gr)	26	30	37	40	45	53	67



AIRX 400N	F5140A00Y	X	X	X	X	X	X	X
AIRX 500N	F5151A00Y	F5151A15Y	F5151A10Y	X	X	X	X	X
AIRX 600N	F5160A00Y	F5160A15Y	F5160A10Y	F5160A19Y	F5160A35Y	F5160A08Y	F5165A60Y	F5165A90Y
AIRX 650N	F5165A00Y	F5165A15Y	F5165A10Y	F5165A19Y	F5165A35Y	F5165A08Y	F5165A60Y	F5165A90Y
AIRX 700N	F5170A00Y	F5170A15Y	F5170A10Y	F5170A19Y	F5170A35Y	F5170A08Y	F5170A60Y	F5170A90Y
AIRX 800N	F5180A00Y	F5180A15Y	F5180A10Y	F5180A19Y	F5180A35Y	F5180A08Y	F5180A060Y	F5180A090Y
AIRX 900N	F5190A00Y	F5190A15Y	F5190A10Y	F5190A19Y	F5190A35Y	F5180A08Y	F5180A060Y	F5180A090Y

### EASY SAIL / EASY SAIL



Excellente résistance à la déchirure dans la chaîne & la trame. Conservation & stabilité du biais après vieillissement. Très faible absorption d'eau. Conseillé pour spis symétriques & asymétriques / Excellent tear resistance in warp & weft. Retention & stability of bias after aging. Very low water absorption. Recommended for symmetrical & asymmetrical spis

Réf.	Désignation	Construction	Poids (gr)	Laize (mm)
864040W	Easysail 40 Blanc	40 x 45	41	1520
864040B	Easysail 40 Bleu	40 x 45	41	1520
864040R	Easysail 40 Rouge	40 x 45	41	1520
864070W	Easysail 70 Blanc	35 x 35	69	1520
864070B	Easysail 70 Bleu	35 x 35	69	1520
864070R	Easysail 70 Rouge	35 x 35	69	1520



## Monofilm / Polyan

### Window X Ply / Window X Ply

Monofilm tramé X polyester noir / Black polyester X-screen monofilm



Réf.	Type	PET Film	Poids	Largeur
864467	Window Mw 150 B	4 mil	4,3 oz	152 cm

### Window DIAX / Window DIAX

Monofilm tramé X polyester blanc / White polyester X-screen monofilm



Réf.	Type	PET Film	Poids	Largeur
F6002P00M	Window Diax	4 mil	4,03oz	137 cm

### Monofilm standard / Monofilm standard

Utilisation principale : Voiles de planche. Aspect transparent.  
Disponible en plusieurs épaisseurs.

/ Main use: Windsurf sails. Transparent appearance.  
Available in several thicknesses.

Réf.	Type	Poids
831023	100 microns (3 mil)	3,5 oz
831025	125 microns (5 mil)	4 oz
831026	175 microns (7 mil)	6,5 oz

### Mylar Gabarit / Mylar template

Principalement utilisé pour réaliser des gabarits de renforts. Il peut aussi servir à la fabrication de lèvres de puits de dérive ou à la réalisation de renforts de fourreau de latte. Aspect laiteux. Opaque.

/ Mainly used to make templates for reinforcement. It can also be used in the manufacture of lips dagger board or carrying reinforcements batten pocket. Milky. Opaque.

831030	250 microns
--------	-------------

### Monofilm autocollant / Monofilm sticker

Livré en laize entière de 1320 cm, en largeur : 30 cm ou par kit de 2 m.

/ Delivered in full width of 1320 cm, width: 30 cm or 2 m kit

831031	100 microns x 1320 ml
831032	100 microns x 300 ml
460711	Kit 30 cm x 2 ml
831032/100	100 microns x 100 ml
831032/200	100 microns x 200 ml

### Monofilm adhésive / Monofilm psa

Grande laize ou bandes en rouleau de 50 m / Wide width or strips in rolls of 50 m.

J872	Monofilm Adhésive Rouleau 50 mm X 50 ml
J874	Monofilm Adhésive Laize 137 cm

### Polyan pour gabarit / Monofilm sticker

Laize 6000 mm / Width of 6000 mm.

867001	Polyan Gabarit - 200 mi - 6000 mm x 45 m
--------	--

# CHALLENGE AILCLOTH



Tissus à voile / Sailcloth

## Bainbridge

## Covering & protection UV

Bandes UV, tauds, capotes, bimini,... / UV Stripes, Canopy, Sprayhood, biminis

### TISSUS ACRYLIQUE / ACRYLICS FABRICS

#### SOLACRYL

Acrylique teint masse - Laize 152 cm / Solution-dyed acrylic - Width 152 cm



#### Solacryl Uncoated Acrylic Canvas

- Dodgers, stack packs, housses de voile, auvents et rembourrage
- Le processus unique Infinity fournit un tissu plus doux, idéal pour les courbes et les formes complexes
- Résistant aux intempéries - qu'il pleuve ou qu'il fasse beau
- Nettoyage facile
- Solidité des couleurs 7-8 note

- Dodgers, stack packs, sail covers, awnings and upholstery
- Unique Infinity Process provides a softer fabric, ideal for complex curves and shapes
- Weather resistant - rain or shine
- Easy clean
- Colour fastness 7-8 rating

#### Solacryl Coated Acrylic Canvas

- Parfait pour une utilisation dans les biminis, tonneaux, capotes, flybridge et couvertures d'amarrage.
- Étanchéité optimale - donnant une colonne d'eau supérieure à 1000 mm.
- Solacryl est enduit sur une face d'une imprégnation de résine hi-tech
- La finition en résine est mate et transparente - aucune apparence blanche ou laiteuse sur la toile.
- Traitement antimicrobien.
- Offre des qualités imperméables supérieures avec respirabilité.
- Les fils acryliques offrent une excellente protection contre les UV.

- Perfect for use in biminis, tonneaus, spray hoods, flybridge and mooring covers.
- Optimal waterproofing - giving a water column in excess of 1000mm.
- Solacryl is coated on one side with hi tech resin impregnation
- Resin finish is matt and clear - no white or milky appearance to canvas.
- Antimicrobial treatment.
- Offers superior waterproof qualities with breathability.
- Acrylic yarns give excellent UV protection.





*Tissus outdoor & indoor / Outdoor & indoor Fabrics*

## Covering & protection UV

### TISSUS ACRYLIQUE / ACRYLICS FABRICS



#### ORCHESTRA

100 % acrylique teint masse / 100% solution-dyed acrylic

Tissu dralon 320 g. Largeur 120 cm. Longueur 60 m. N'hésitez pas à nous demander une gamme d'échantillon.  
/ Dralon fabric 320 g. Width: 120 cm. Length: 60 m. Feel free to ask us a range of sample.

## SOLIDS

GL M 966028	Noir 6028	GL M 960681	Dune 0681	968778	Chardon 8778
GL M 960171	Carbonne U171	M 967548	Ivoire 7548	M 967264	Océan 7264
GL M 968203	Ardoise 8203	M 967133	Naturel 7133	966022	Marine 6022
GL M 966196	Pierre 6196	GL M 964001	Ecru 0001	960170	Pink U170
GL M 960387	Argile U387	966318	Blé 6318	960003	Vert 0003
GL M 966088	Gris 6088	960034	Sable 0034	967554	Cassis 7554
967552	Argent 7552	968777	Safran 8777	968207	Châtaigne 8207
GL M 967559	Taupe 7559	966688	Turquoise 6688	967297	Emeraude 7297
968200	Chanvre 8200	968204	Bleuet 8204	GL M 963914	Rouge 3914
968902	Beige 8902	968901	Paon 8901	M 968206	Bordeaux 8206
GL M 966020	Grège 6020	GL M 966687	Foret 6687	GL 960020	Vermillon 0020
966610	Vanille 6610	960388	Azur U388	966316	Jaune 6316
M 960805	Brownie U224	968201	Fougère 8201	960867	Mandarine 0867
960613	Marron 0613	GL 960017	Bleu 0017	960018	Orange 0018
968776	Cacao 8776	968238	Bleu nuit 8238	GL M 968205	Papaye 8205
M 968891M	Toast 8891	966720	Saphir 6720	GL M 967560	Paille 7560
967244	Amande 7244				

GL GRANDE LAIZE

M ORCHESTRA MAX

## ORCHESTRA

### FLAMMÉS

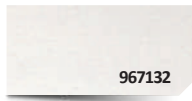

967132

Graphite Flammé 7132

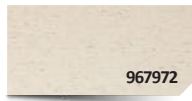

967972

Perle Flammé 7972

### CHINÉS & TWEEDS

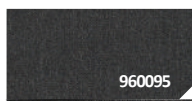

960095

Basalte Chiné U095

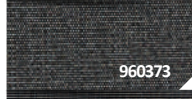

960373

Macadam Tweed U373

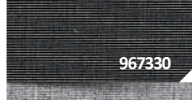

967330

Charcoal Tweed 7330



GL M

968396

Souris Chiné 8396



GL M

960104

Flanelle Chiné U104



960190

Gris Tweed U190



960370

Papyrus Tweed U370

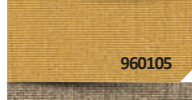

960105

Curry Chiné U105

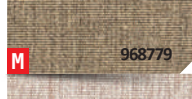

M

968779

Bruyère Chiné 8779



968904

Lin Chiné 8904



960321

Granny Chiné U321

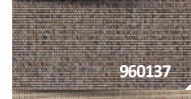

960137

Vison Tweed U137



960140

Gazelle Tweed U140



960371

Chamois Tweed U371

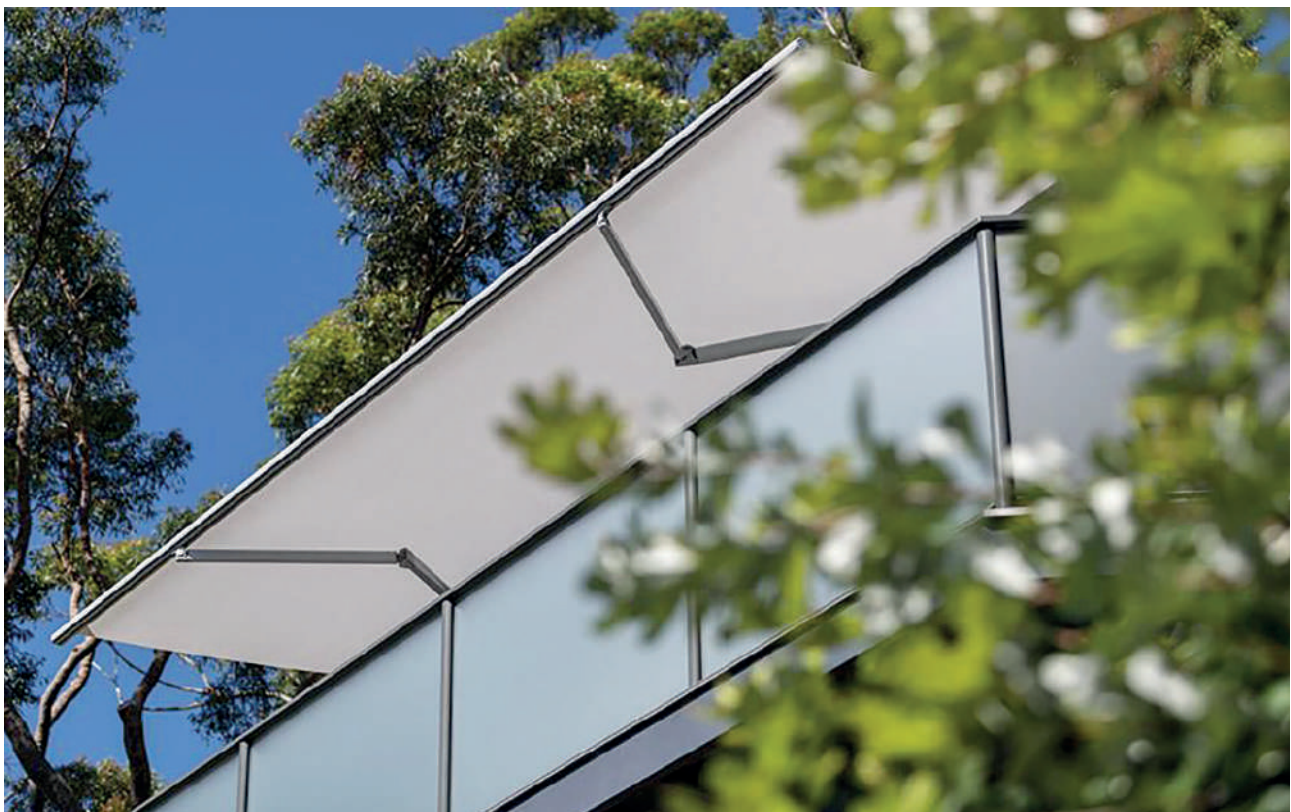

## Covering & protection UV

TISSUS ACRYLIQUE / ACRYLICS FABRICS



### ORCHESTRA

## PIQUÉS



## SWITCH

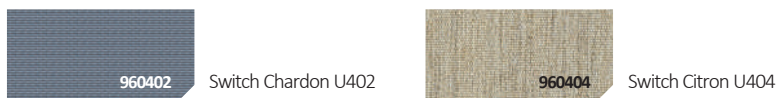

## ↳ ORCHESTRA GRANDE LAIZE **GL**

Réf.	Désignation	Poids (g/m <sup>2</sup> )	Largeur	Rouleau
969996	Dralon GD Laize	320 g	165 cm (pièce ml)	60 m
969997	Dralon GD Laize	320 g	200 cm (pièce ml)	60 m
969998	Dralon GD Laize	320 g	250 cm (pièce ml)	50 m
969999	Dralon GD Laize	320 g	320 cm (pièce ml)	40 m

## POUR COMMANDER **GL**

Réf.	Désignation
Ex. : 96-964001	Dralon GD Laize
Ex. : 97-966196	Dralon GD Laize
Ex. : 98-966028	Dralon GD Laize
Ex. : 99-966687	Dralon GD Laize

## ↳ ORCHESTRA MAX ENDUIT **M**

Réf.	Désignation	Poids (g/m <sup>2</sup> )	Largeur	Rouleau
ORCHESTRAM	ORCHESTRA MAX	330 g	120 cm UNIS - ML	60 m



IMPERMÉABLE



LAVAGE FACILE

## ↳ ORCHESTRA RAYÉ **I**

Réf.	Désignation	Largeur	Rouleau
97500	ORCHESTRA rayé	120 cm - ML	60 m



Tissus outdoor & indoor / Outdoor & indoor Fabrics



	ORCHESTRA	MAX
Composition / Composition	100 % acrylique	100 % acrylique enduit
Finition / Finish	Anti-salissures et imper	Anti-salissures et imper
Poids / Weight	300 g/m <sup>2</sup>	330 g/m <sup>2</sup>
Largeur / Width	120 cm	120 cm
Résistance rupture / Breakage resistance	145/90 daN	154/105 daN
Imper Schmerber	350 mm	1200 mm
Solidité lumière / Light fastness	7 à 8/8	7 à 8/8

## Covering & protection UV



### TISSUS ACRYLIQUE / ACRYLICS FABRICS

#### SUNBRELLA

☞ Sunbrella "NEW". Laize : 152 cm, longueur : 50m / Sunbrella "new". Width: 152, length: 50 m

#### COULEUR REGULAR



#### COULEUR PREMIUM



SUNBRELLA	
Composition / Composition	100 % acrylique
Finition / Finish	Spécial Marine
Poids / Weight	300 g/m <sup>2</sup>
Largeur / Width	152 cm
Résistance rupture / Breakage resistance	140/90 daN
Imper Schmerber	400 mm
Solidité lumière / Light fastness	7 à 8/8



## SUNBRELLA "PLUS"

☞ Sunbrella " PLUS " possède une enduction anti fongique marine.  
Laize de 152 cm. Longueur 50 m.

/ The Sunbrella "Plus" has a marine antifungal coating. Width: 152 cm. Length 50 m



### COULEUR REGULAR

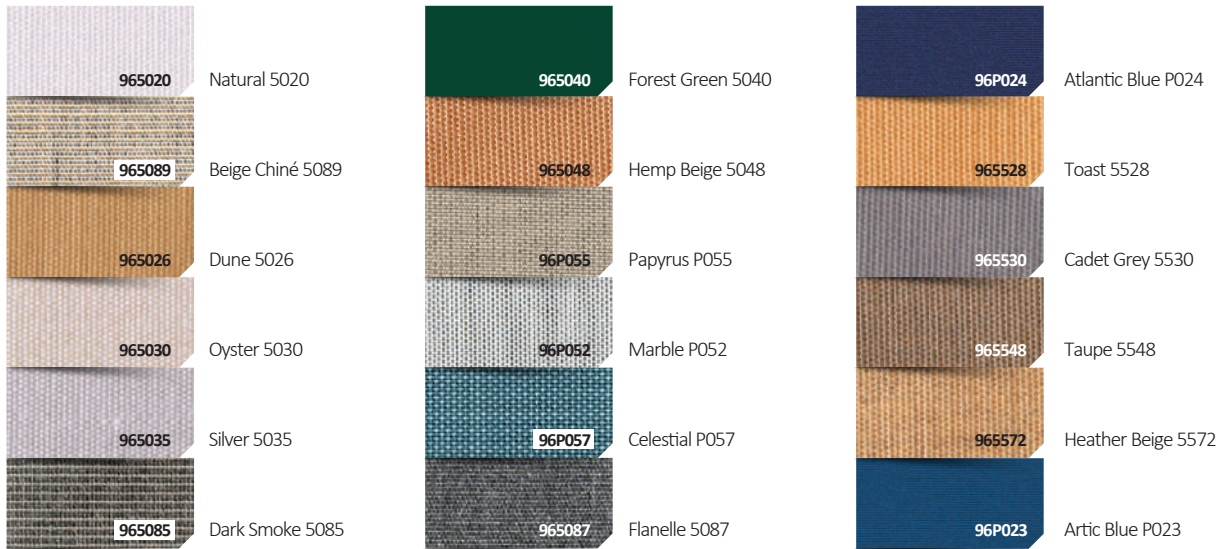

### COULEUR PREMIUM



#### SUNBRELLA PLUS

Composition / Composition	100 % acrylique enduit
Finition / Finish	Spécial Marine
Poids / Weight	320 g/m <sup>2</sup>
Largeur / Width	152 cm
Résistance rupture / Breakage resistance	140/130 daN
Imper Schmerber	1000 mm
Solidité lumière / Light fastness	7 à 8/8

## Covering & protection UV



### TISSUS ACRYLIQUE / ACRYLICS FABRICS

#### TISSUS ET BANDES " FURLING " / FABRICS AND TAPES "FURLING"

##### STANDARD

Bandes UV réalisées à partir d'un tissu acrylique léger 200 g. Laize : 1650 et 540\* cm  
 / UV tapes made from a lightweight acrylic fabric 200 g. Width: 1650 and 540\* cm



##### ADHÉSIVE / PSA

Bandes UV réalisées à partir d'un tissu acrylique léger 200 g. Laize : 1500 et 500\*\* cm  
 / UV tapes made from a lightweight acrylic fabric 200 g. Width: 1500 and 500\*\* cm

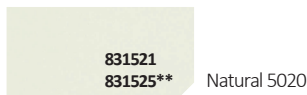

Nuancier sur demande / Samples on request

Decoupe en bande sur demande.

	FURLING	FURLING ADHÉSIVE
Composition / Composition	100 % acrylique	100 % acrylique
Finition / Finish	Spécial Marine	Spécial Marine
Poids / Weight	200 g/m <sup>2</sup>	250 g/m <sup>2</sup>
Largeur / Width	165 cm	150 cm
Résistance rupture / Breakage resistance	120/40 daN	135/40 daN
Imper Schmerber	200 mm	240 mm
Solidité lumière / Light fastness	7 à 8/8	7 à 8/8

#### SUNBRELLA SEAMARK

Acrylique avec enduction PVC - Laize 152 cm, rouleau 45 m / Acrylic with PVC coating - Width 152 cm, roll 45 m.

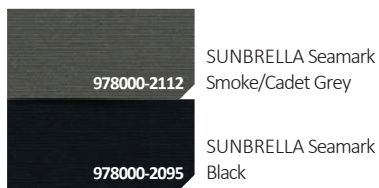

#### SUNBRELLA SURLAST

Polyester avec enduction PU sur une face - Laize 152 cm, rouleau 60 ml / Polyester with PU coating on one side - Width 152 cm, roll 60 ml

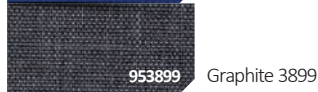
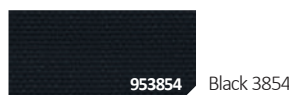
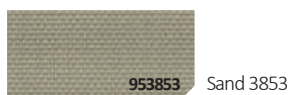

	SEAMARK	SURLAST
Composition / Composition	100 % acrylique	100 % Polyester
Finition / Finish	Enduction PVC	Enduction PU
Poids / Weight	240 g/m <sup>2</sup>	542 g/m <sup>2</sup>
Largeur / Width	152 cm	152 cm
Résistance rupture / Breakage resistance	217/152 daN	217/152 daN
Imper Schmerber	850 mm	> 5000 m
Solidité lumière / Light fastness	4/5	7 à 8/8



## GALON SUNBRELLA



### SANGLE DE BORDAGE ACRYLIQUE / ACRYLIC BIMINI BRAID

/// Sangle utilisée pour galonner les tauds bimini Dralon. Longueur : 150 m. Largeur : 23 mm  
 / Strap used to braid the bimini awning Dralon. Length: 150 m. Laize: 23 mm

#### COULEUR REGULAR



884310 Taupe 5548



884312 Natural 5020



884309 Dune 5026

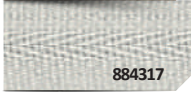

884317 Stone P011



884313 Linen 5050

#### COULEUR PREMIUM

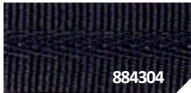

884304 Captain Navy 5057



884305 Marine Blue 5031



884307 Jet Black 5032

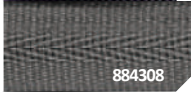

884308 Charcoal Grey 5049



## Covering & protection UV



### TISSUS POLYESTER / POLYESTER FABRICS

#### ↳ ODYSSEY

Enduction acrylique 1 face. Excellente résistance et durabilité. 215 gr/m<sup>2</sup>. Longueur : 68,6 m  
 / Acrylic one side coated 1 face. Very good tensile tear and life time. 215 gr/m<sup>2</sup>. Length: 68,6 m

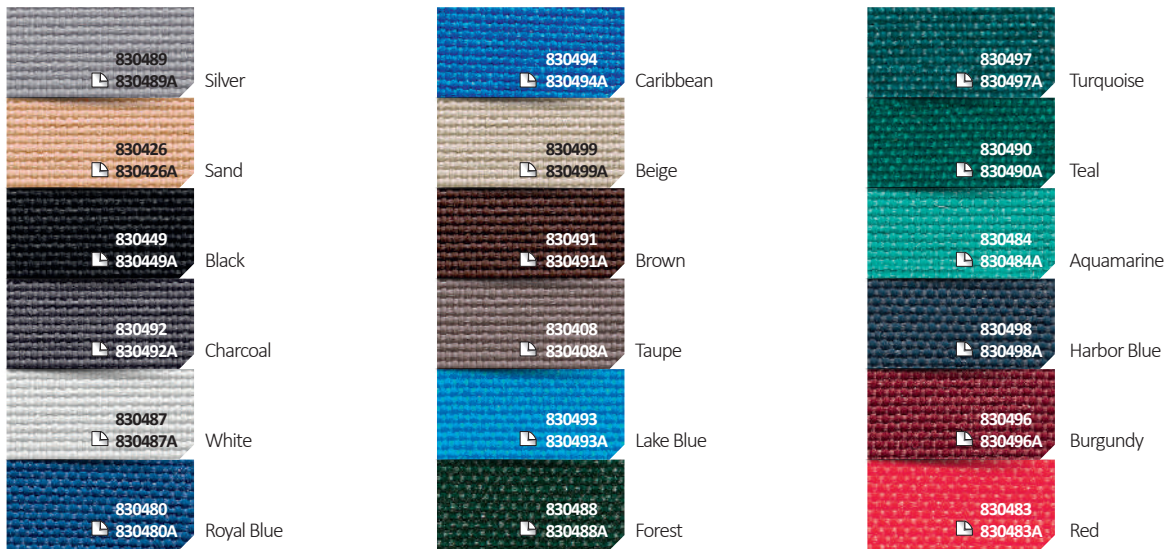

Decoupe en bande sur demande. ✂  
 Adhésivé / PSA

- Traitement anti UV +++
- Forte stabilité dimensionnelle
- Reste souple (ne marque pas)
- Haute résistance à l'abrasion
- Très bonne tenue des couleurs
- Hydrofuge
- Résistant aux moisissures
- UV Treatment +++
- High stability
- Stay Flexible
- High abrasive resistance
- Very good colour fastness
- Waterproof
- Mould resistant

#### ↳ ODYSSEY FR®

Enduction acrylique 1 face. Excellente résistance et durabilité. Traitement feu. 245 gr/m<sup>2</sup>. Longueur : 91 m  
 / Acrylic one side coated 1 face. Very good tensile tear and life time. Flame retardant. 245 gr/m<sup>2</sup>. Length: 91 m



	ODYSSEY	ODYSSEY PSA	ODYSSEY FR®
Composition / Composition	100% polyester	100% polyester	100% polyester
Finition / Finishing	Enduction 1 face	Enduction 1 face	Enduction 1 face
Poids / Weight	215 g/m <sup>2</sup>	271 g/m <sup>2</sup>	245 g/m <sup>2</sup>
Largeur / Width	162,5 cm	152 cm	162,5 cm
Garantie / Warranty	3 ans	3 ans	3 ans
Application / Application	Bandes UV, tauds, capotes, bimini, housse	Bandes UV, tauds, capotes, bimini, housse	Bandes UV, tauds, capotes, bimini, housse

## SOFTOUCH

# Softouch

/// Tissu polyester enduit avec feutrine 1 face. Largeur : 152 cm Longueur : 45 m

/ Polyester coated canvas fabric with soft non woven. Width: 152 cm Length: 45 m



864650 Silver grey



864651 Black

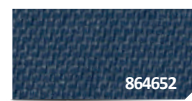

864652 Navy

## SOLARTEX 300

/// Tissu polyester teint masse. Largeur : 160 cm Longueur : 50 m

/ Solution-dyed polyester fabric. Width: 160 cm Length: 50 m

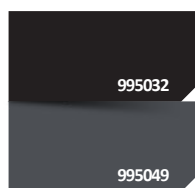

995032 Black

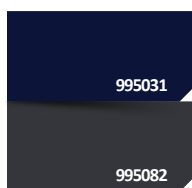

995031 Blue

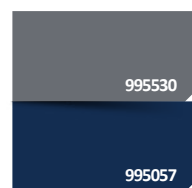

995530 Cadet Grey

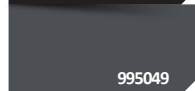

995049 Charcoal Grey

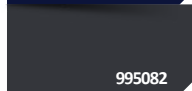

995082 Graphite



995057 Navy Blue

	SOLARTEX 300	SOFTOUCH
<b>Composition / Composition</b>	100 % polyester avec enduction PU	100 % polyester avec feutre polyester une face
<b>Poids / Weight</b>	300 g/m <sup>2</sup>	375 g/m <sup>2</sup>
<b>Largeur / Width</b>	160 cm	152 cm
<b>Utilisation / Use</b>	Tauds, Lazy, Protection outdoor... Contre les intempéries sur le dessus Le dessous " soft " ne rayera pas le support	Protection coque, carrosserie Contre les intempéries sur le dessus Le dessous " soft " ne rayera pas le support
<b>Garantie / Warranty</b>	Stabilité dimensionnelle Anti moisissure - Hydrofuge Résistance à l'abrasion - 5 ans	Stabilité dimensionnelle Anti moisissure - Hydrofuge Résistance à l'abrasion - 5 ans

## TOP NOTCH 9

# TOP NOTCH 9

/// Polyester teint masse, enduction fluo carbone - réversible, respirant, enduction 2 faces.

Laize : 152 cm, rouleau 45,7 m

/ Polyester dyed mass, fluo carbon coating - reversible, breathable, 2 sides coated. Width: 152 cm, roll 45.7 m

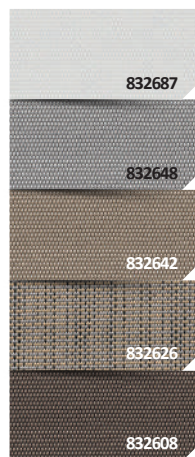

832687 White



832648 Silver

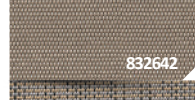

832642 Tan

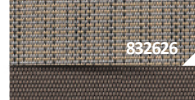

832626 Pebble Tweed



832608 Taupe



8322692 Charcoal

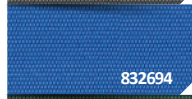

832694 Caribbean

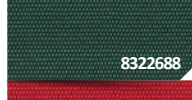

8322688 Forest



8322683 Red

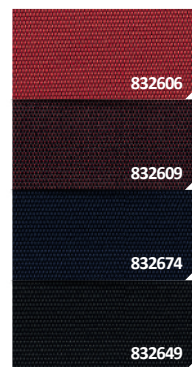

832606 Cardinal Red



832609 Burgundy



832674 Admiral Navy



832649 Black

- |                                  |                             |
|----------------------------------|-----------------------------|
| - Traitement anti UV +++         | - UV Treatment +++          |
| - Forte stabilité dimensionnelle | - High stability            |
| - Reste souple (ne marque pas)   | - Stay Flexible             |
| - Haute résistance à l'abrasion  | - High abrasive resistance  |
| - Très bonne tenue des couleurs  | - Very good colour fastness |
| - Hydrofuge                      | - Waterproof                |
| - Résistant aux moisissures      | - Mould resistant           |

	TOP NOTCH 9
<b>Composition / Composition</b>	100% Polyester
<b>Finition / Finishing</b>	Enduction 2 faces
<b>Poids / Weight</b>	305 g/m <sup>2</sup>
<b>Garantie / Warranty</b>	5 ans
<b>Application / Application</b>	Bandes UV, tauds, capotes, bimini, housse
<b>Colonne d'eau / Water pillar</b>	400 mm

## Covering & protection UV

### STAMOID

#### STAMOID EASY

↳ Enduction 1 face PVC. Largeur : 260 cm. Longueur : 30 m / Width: 260 cm. Length: 30 m

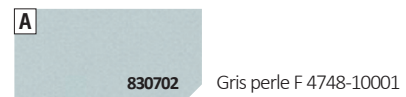
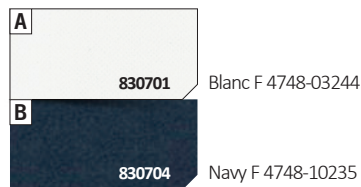
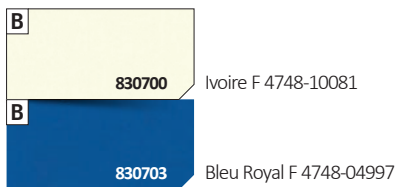

STAMOID EASY	
Description / Description	Composite multi-couche
Support / Support	Polyester HT 1100 dtex
Poids / Weight	430 g/m <sup>2</sup>
Largeur / Width	260 cm
Résistance rupture / Breakage resistance	230/230 daN/5 cm
Résistance déchirure / Tear resistance	32/28 daN

#### STAMOID HEAVY COVER

↳ Stamoid HEAVY COVER. Largeur : 260 cm. Longueur : 30 m / Stamoid HEAVY COVER. Width: 260 cm. Length: 30 m

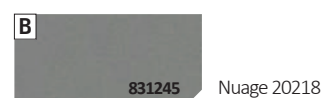
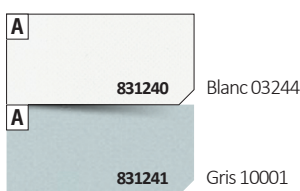

STAMOID HEAVY COVER	
Description / Description	Composite multi-couche
Support / Support	Polyester HT 1100 dtex
Largeur / Width	260 cm
Poids / Weight	465 g/m <sup>2</sup>
Résistance rupture / Breakage resistance	230/230 daN/5 cm
Résistance déchirure / Tear resistance	30/25 daN/5 cm
Stabilité lumière / Light stability	>=7

## STAMOID LIGHT

Stamoid Light. Largeur : **PL = 150 cm**, longueur : 50 m - **GL = 300 cm**, longueur : 30 m  
 / Stamoid Light. Widths: PL = 150 cm, length: 50 m - GL = 300 cm, length: 30 m

PL	<b>A</b>	830246-1 830246	Neige 10309	GL	<b>A</b>	831249	Anthracite 20166	PL	<b>C</b>	831253-1	Bordeaux 20042
GL	<b>B</b>	830247	Crème 10204	PL	<b>A</b>	831250-1 831250	Blanc 03244	GL	<b>A</b>	831304	Navy 10235
PL	<b>B</b>	830248-1	Désert 20217	PL	<b>A</b>	831251-1 831251	Sable 01897	PL	<b>C</b>	831254-1	Green 20031
PL	<b>A</b>	831246-1	Argent 10124	PL	<b>A</b>	831252-1 831252	Gris Perle 10001	GL	<b>B</b>	831255	Taupe 20165
PL	<b>B</b>	831247-1	Nuage 20218	GL	<b>A</b>	831293	Ivoire 10081	PL	<b>A</b>	831256-1 831256	Noir 00002
PL	<b>A</b>	831248-1 831248	Bleu Roy 04997								

## STAMOID TOP

Stamoid TOP. Largeur : **PL = 150 cm**, longueur : 50 m - **GL = 260 cm**, longueur : 30 m  
 / Stamoid TOP. Widths: PL = 150 cm, length: 50 m - GL = 260 cm, length: 30 m

PL	<b>A</b>	831364-1 831364	Neige 10309	PL	<b>B</b>	831369-1	Anthracite 20166	PL	<b>C</b>	831372-1	Bordeaux 20042
GL	<b>A</b>	831365-1 831365	Crème 10204	PL	<b>A</b>	831362-1 831362	Blanc 03244	PL	<b>B</b>	831373-1	Navy 10235
PL	<b>B</b>	831366-1	Désert 20217	PL	<b>A</b>	831370-1 831370	Sable 01897	PL	<b>C</b>	831374-1	Evergreen 20031
PL	<b>B</b>	831368-1	Bleu Roy 04997	PL	<b>A</b>	831363-1 831363	Gris Perle 10001	PL	<b>B</b>	831375-1	Taupe 20165
PL	<b>B</b>	831367-1	Nuage 20218	PL	<b>A</b>	831371-1	Ivoire 10081	PL	<b>B</b>	831376-1 831376	Noir 00002



	STAMOID LIGHT	STAMOID TOP
Enduction / Induction	1 face PVC	2 faces PVC
Description / Description	Composite multi-couche	Composite multi-couche
Support / Support	Polyester 280 dtex	Polyester 280 dtex
Poids / Weight	300 g/m <sup>2</sup>	430 g/m <sup>2</sup>
Largeur / Width	150 cm - 300 cm	150 cm - 260 cm
Résistance rupture / Breakage resistance	100/100 daN / 5 cm	120/120 daN / 5 cm
Stabilité lumière / Light stability	>7	>7
Températures extrêmes / Extreme temperatures	-20° C / +70° C	-20° C / +70° C

## Covering & protection UV

### STAMOID

#### STAMOID SMART

Stamoid SMART 1. Longueur : 30 m, largeur : 250 cm / *Stamoid MART 1. Length: 30 m, Width: 250 cm*

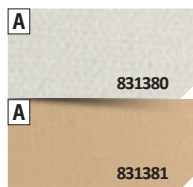

Blanc F4160-03244

Sable F4160-01897

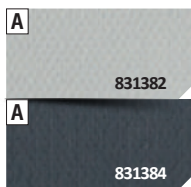

Perle F4160-10001

Antracite F4160-20166



Royal F4160-04997



- Respirant / *- Breathable*
- Etanche / *- Waterproof*
- Léger / *- Light*
- Compact / *- Compact*
- Résistant aux UV / *- UV resistant*
- Facilité d'entretien / *- Easy to maintain*

#### STAMOID EDGE

Stamoid EDGE. Longueur : 50 m, largeur : **PL = 20 mm**, (ou **GL = 25**) / *Stamoid EDGE. Length: 50 m, Width: PL=20 mm (or GL=25)*

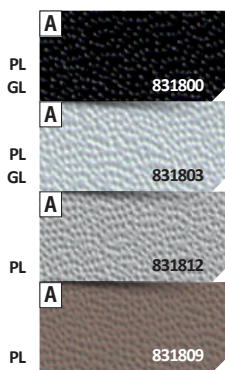

Noir 00002

Gris 10001

Nuage 20218

Taupe 20165

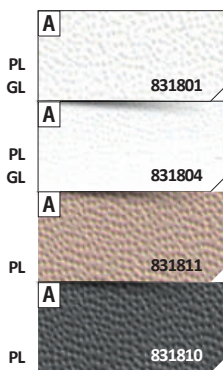

Blanc 10309

Neige 03244

Désert 20217

Anthracite 20166

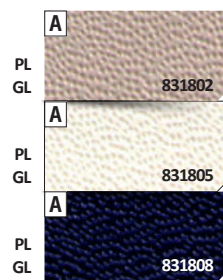

Beige 01897

Ivoire 10081

Navy 10235



#### STAMOID SMART

Enduction / <i>Induction</i>	PVC 1 face
Support / <i>Support</i>	Polyester HT 280/550 dtex
Poids / <i>Weight</i>	280 g/m <sup>2</sup>
Largeur / <i>Width</i>	250 cm
Résistance rupture / <i>Breakage resistance</i>	125/140 daN
Résistance déchirure / <i>Tear resistance</i>	14/30 daN
Stabilité lumière / <i>Light stability</i>	≥ 7

Sur commande / *On order*

////// **TOILE PVC ENDUITE** / PVC coated fabric

**Serge Ferrari**

↳ **PRÉCONTRAIT PROTECT**

/// **COVER 905 F3.** Laize : 300 cm, longueur : 30 m / *COVER 905 F3. Width: 300 cm, length: 30 m*

	Blanc RAL 9016 31066		Colbat RAL 5013 31050		Gris Clair RAL 7035 31069
	Ivoire RAL 1015 1076		Outremer RAL 5002 31051		Gris RAL 7037 31070
	Jaune RAL 1003 31061		Ciel RAL 5015 31053		Gris Agate RAL 7038 31071
	Orangé RAL 2004 31063		Vert RAL 6026 31055		Noir RAL 9005 31075
	Rouge RAL 3002 31065		Beige 31035		

905

/// **COVER 705.** Laize : 270 cm, longueur : 30 m / *COVER 705. Width: 270 cm, length: 30 m*

	Blanc 1066		Bleu Clair 20017		Gris Aghate 1071
	Blanc Perlé 1076		Vert Mousse 50201		Gris Fenêtre 1072
	Ivoire Clair 50076		Vert Opale 1055		Alu 1267
	Rouge Carmin 1065		Gris Clair 1069		Gris anthracite 1074
	Bleu Outremer 1051		Gris Poussière 1070		Noir 1075
	Bleu Ciel 1053				

705

Tissus outdoor & indoor / Outdoor & indoor Fabrics

	905	705
<b>Fil / Thread</b>	2x1100 dtex PES HT	1100 dtex PES HT
<b>Poids / Weight</b>	900 g/m <sup>2</sup>	670 g/m <sup>2</sup>
<b>Largeur / Width</b>	300 cm	270 cm
<b>Résistance rupture / Breakage resistance</b>	400/400 daN/5 cm	250/250 daN/5 cm
<b>Finition / Finishing</b>	Vernis Biface	Vernis Biface
<b>Applications / Applications</b>	Bâches forte résistance	Bâches, rideaux souples

**Covering & protection UV**

**TOILE PVC ENDUITE / PVC coated fabric**



**POLYPLAN 725**

Laize 250 cm, rouleau de 50 m / Width: 250 cm, roll of 50 m



Blanc 725



Gris 725



Bleu 725

POLYPLAN 725	
Fil / Thread	1100 dtex PES HT
Poids / Weight	580 g/m <sup>2</sup>
Largeur / Width	250 cm
Résistance rupture / Breakage resistance	230/230 daN/5 cm
Applications / Applications	Bâches, tauds

**FLEXLIGHT**



FLEXLIGHT 402N. Laize : 267 cm, longueur : 60 m / FLEXLIGHT 402N. Width: 267 cm, length: 60 m



Blanc 8104

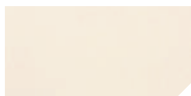

Ivoire 8341



Translucide 1399

FLEXLIGHT 602N translucide. Laize : 267 cm, longueur : 50 m / FLEXLIGHT 602N translucent. Width: 267 cm, length: 50 m

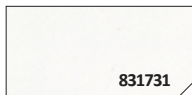

Blanc 8100

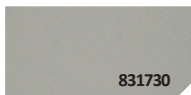

Gris Clair 20701

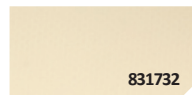

Vanille 8341

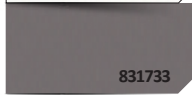

Gris Foncé 1070

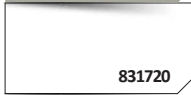

Blanc Opaque 8503

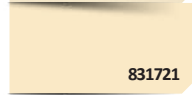

Beige Opaque 50020

**750 gr** pour les versions opaques

602N 402N



////// **TOILE PVC ENDUITE / PVC coated fabric**

**Serge Ferrari**

↳ **SOLTIS PROOF**

/// **SOLTIS PROOF 502 SATIN.** Laize : 180 cm, longueur : 40 m / *SOLTIS PROOF 502. Width: 180 cm, length: 40*

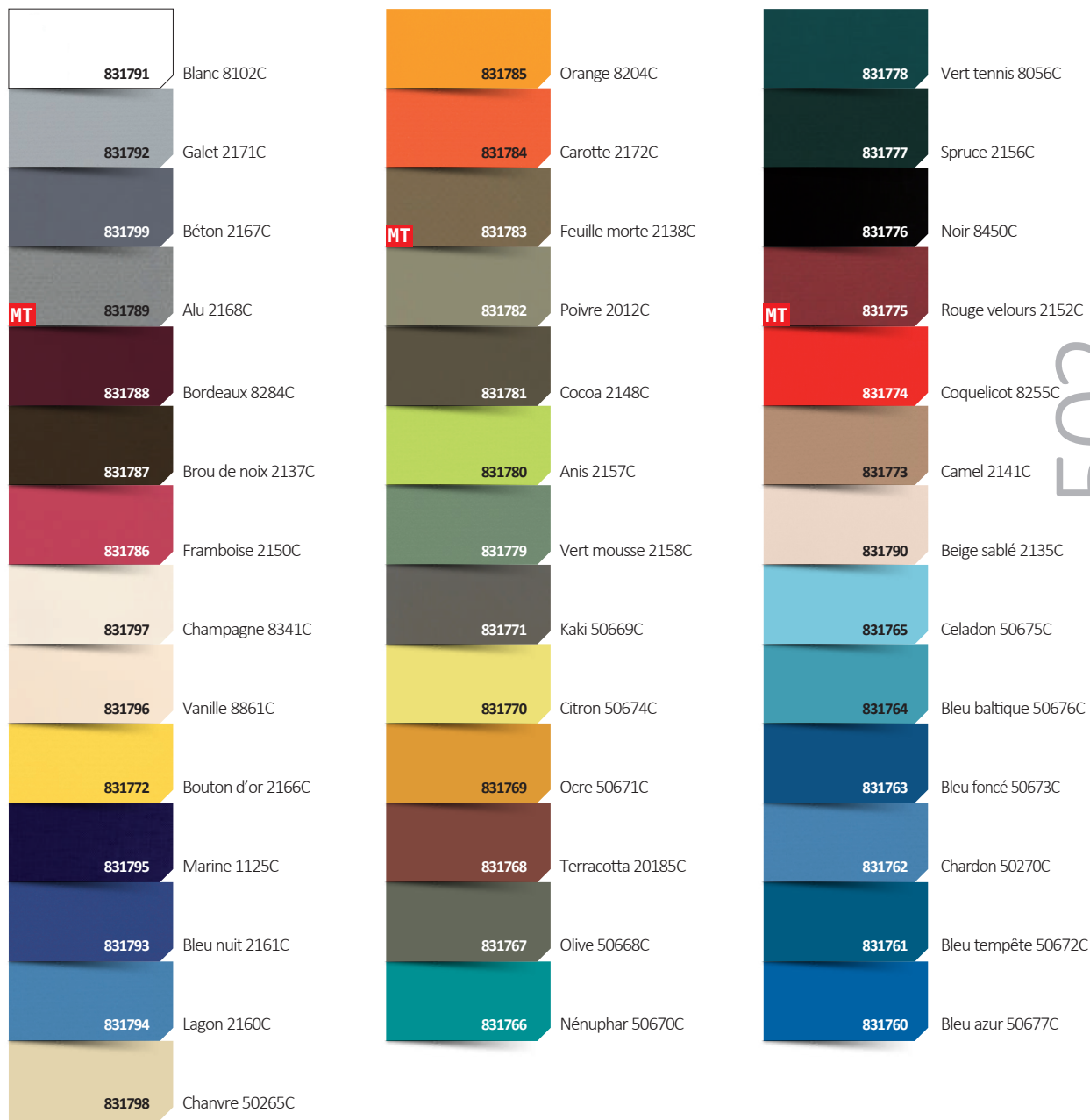

Tissus outdoor & indoor / Outdoor & indoor Fabrics

502

Tous les coloris disponibles " STRIPES "

	402	602	502
<b>Fil / Thread</b>	1100 dtex PES HT	1100 dtex PES HT	1100 dtex PES HT
<b>Poids / Weight</b>	490 g/m <sup>2</sup>	650 g/m <sup>2</sup>	570 g/m <sup>2</sup>
<b>Largeur / Width</b>	267 cm	267 cm	180 cm
<b>Résistance rupture / Breakage resistance</b>	250/250 daN/5 cm	230/220 daN/5 cm	200/200 daN/5 cm
<b>Finition / Finishing</b>	Vernis Biface	Vernis Biface	Vernis Biface
<b>Réaction au feu / Fire resistance</b>	M2	M2	M2
<b>Applications / Applications</b>	Auvent, pergola, lodges, stand, tente publicitaire...	- 30° C / +70° C	Terrasses, auvents, velums, ...

MT Coloris métallisés / Metallic colors

**Protection solaire**

**SOLTIS**

**TOUCH**

/// SOLTIS TOUCH. Largeur : **PL = 180 cm**, longueur : 45 m - **GL = 270 cm**, longueur : 30 m  
 / SOLTIS TOUCH. Widths: **PL = 180 cm**, length: 45 m - **GL = 267 cm**, length: 30 m

GL PL	<b>834200</b> <b>834200PL</b>	Jasmin 50982	GL	<b>834210</b>	Bourgeon 50954	GL	<b>834219</b>	Pacifique 50961
GL PL	<b>834201</b> <b>834201PL</b>	Carrare 50937	GL	<b>834211</b>	Roseau 50964	GL	<b>834220</b>	Crépuscule 50950
GL	<b>834202</b>	Nacre 50953	GL PL	<b>834212</b> <b>834212PL</b>	Ficelle 50957	GL PL	<b>834221</b> <b>834221PL</b>	Cobalt 50944
GL PL	<b>834203</b> <b>834203PL</b>	Silex 50946	GL PL	<b>834213</b> <b>834213PL</b>	Biscuit 50960	GL	<b>834222</b>	Tornado 50963
GL PL	<b>834204</b> <b>834204PL</b>	Gris agate 50945	GL PL	<b>834214</b> <b>834214PL</b>	Érable 50952	GL PL	<b>834223</b> <b>834223PL</b>	Tonka 50939
GL PL	<b>834205</b> <b>834205PL</b>	Raphia 50959	GL PL	<b>834215</b> <b>834215PL</b>	Céleste 50938	GL PL	<b>834224</b> <b>834224PL</b>	Tanin 50948
GL	<b>834206</b>	Glacier 50955	GL PL	<b>834216</b> <b>834216PL</b>	Éléphant 50943	GL	<b>834225</b>	Moka 50958
GL PL	<b>834207</b> <b>834207PL</b>	Blé 50941	GL	<b>834217</b>	Opaline 50947	GL	<b>834226</b>	Acajou 50951
GL PL	<b>834208</b> <b>834208PL</b>	Curcuma 50942	GL	<b>834218</b>	Rivage 50949	GL PL	<b>834227</b> <b>834227PL</b>	Fusain 50940
GL	<b>834209</b>	Citrine 50962						



<b>SOLTIS TOUCH</b>	
<b>Description / Description</b>	Polyester Hte Tenacité
<b>Enduction / Induction</b>	PVC
<b>Largeur / Width</b>	180 et 270 cm
<b>Poids / Weight</b>	470 g/m <sup>2</sup>
<b>Épaisseur / Thickness</b>	0,75 mm
<b>Coefficient ouverture / Opening ratio</b>	3 %
<b>Résistance au Feu / Fire resistance</b>	M1

## SOLTIS

### SOLTIS HORIZON 86

Serge Ferrari

SOLTIS HORIZON 86. Largeur : **PL = 177 cm**, longueur : 50 m - **GL = 267 cm**, longueur : 40 m  
 / SOLTIS HORIZON 86. Widths: **PL = 177 cm**, length: 50 m - **GL = 267 cm**, length: 40 m

PL GL		831434PL 831434	Alu / Crege 2046
PL		831551PL	Brique 51180
PL		831552PL	Rouge Profond 51181
PL		831444-51182PL	Bleu Franc 51182
PL		831438PL	Alu / Anthracite 2068
PL GL		831439PL 831439	Béton 2167
PL		831444-2157PL	Anis 2157
PL		831442PL	Orange 8204
PL GL		831444PL 831444	Alu / Alu 2048
PL GL		831445PL 831445	Métal Martelé 2045
PL GL		831446PL 831446	Alu / Blanc 2051
PL GL		831447PL 831447	Beige Sablé 2135
PL GL		831448PL 831448	Anthracite 2047
PL GL		831449PL 831449	Galet 2171
PL GL		831450PL 831450	Blanc 2044
PL GL		831451PL 831451	Bronze 2043
PL GL		831452PL 831452	Champagne 2175
PL		831444-50690PL	Blanc Neige 50690
PL GL		831454PL 831454	Poivre 2012
PL		831444-51176PL	Noir Profond 51176
PL		831494PL	Bouton d'Or 2166
PL		831495PL	Rouge 8255
PL		831550PL	Vert Mousse 2158



Tissus outdoor & indoor / Outdoor & indoor Fabrics



#### SOLTIS HORIZON

Description / Description	Polyester Hte Tenacité
Enduction / Induction	PVC
Largeur / Width	177 et 267 cm
Poids / Weight	380 g/m <sup>2</sup>
Epaisseur / Thickness	0,45 mm
Coefficient ouverture / Opening ratio	14 %
Résistance au Feu / Fire resistance	M1

## Protection solaire

### SOLTIS

#### SOLTIS PERFORM 92

Largeur : **PL = 177 cm**. Longueur : 50 m / Width: **PL = 177 cm**. Length: 50 m

Largeur : **GL = 267 cm**. Longueur : 40 m / Width: **GL = 267 cm**. Length: 40 m

PL	<b>A</b>	831460-50303	Quartz 50303	PL	<b>A</b>	831469	831469L	Beige Sable 2135	PL	<b>A</b>	831487	Or 50273	
PL	<b>B</b>	831460-50690	Blanc Neige 50690	PL	<b>A</b>	831475	831475L	Poivre 2012	PL	<b>B</b>	831460-51179	Vert De Gris 51179	
PL	<b>B</b>	831460-50843	Karité 50843	PL	<b>A</b>	831476	831476L	Chanvre 50265	PL	<b>A</b>	831460-51180	Brique 51180	
PL	<b>A</b>	831460-50850	Taupe 50850	PL	<b>A</b>	831477	831477L	Nuage 50272	PL	<b>A</b>	831492	831492L	Alu/Alu 2048
PL	<b>A</b>	831459	Havane 50266	PL	<b>B</b>	831460-51176	831460-51176L	Noir Profond 51176	PL	<b>A</b>	831460-51181	Rouge Profond 51181	
PL	<b>A</b>	831460	831460L	Blanc 2044	PL	<b>A</b>	831480	831480L	Bronze 2043	PL	<b>A</b>	831497	Bouton D'or 2166
PL	<b>A</b>	831461	831461L	Champagne 2175	PL	<b>A</b>	831460-51177	Gris Foncé 51177	PL	<b>A</b>	831498	831498L	Métal Martelé 2045
PL	<b>A</b>	831462	831462L	Galet 2171	PL	<b>A</b>	831482	831482L	Alu/Grège 2046	PL	<b>A</b>	831499	Cuivre 50274
PL	<b>A</b>	831463	831463L	Béton 2167	PL	<b>B</b>	831483	Anis 2157	PL	<b>A</b>	831676	831676L	Alu/Blanc 2051
PL	<b>A</b>	831464	831464L	Anthracite 2047	PL	<b>A</b>	831484	Vert Mousse 2158	PL	<b>A</b>	831460-51182	Bleu Franc 51182	
PL	<b>A</b>	831467	Rouge 8255	PL	<b>A</b>	831460-51178	Gris Céleste 51178	PL	<b>A</b>	831460-8056	Vert Tennis 8056		
PL	<b>A</b>	831468	Orange 8204	PL	<b>A</b>	831486	Alu/Anthracite 2068	PL	<b>A</b>	831679	Lagon 2160		
PL	<b>B</b>	831685	Coléoptère 2149										

Existe en OPAQUE (B92) / Exists in Opaque (B92)



#### SOLTIS PERFORM 92

Description / Description	Polyester Hte Tenacité
Enduction / Induction	PVC
Largeur / Width	177 et 267 cm
Poids / Weight	420 g/m <sup>2</sup>
Epaisseur / Thickness	0.45mm
Coefficient ouverture / Opening ratio	3 %
Résistance au Feu / Fire resistance	M1

## SOLTIS

### SOLTIS LOUNGE 96

**Serge Ferrari**

Laize : 120 cm, longueur : 50 m **ET** Laize : 267 cm, longueur : 40 m / Width: 120 cm, length: 50 m & Width: 267 cm, length: 40 m

<b>A</b> 831470 Blanc 8102	<b>A</b> 831473 Anthracite 2047	<b>B</b> 831650 Rouge 8255
<b>A</b> 831471 Galet 2171	<b>A</b> 831474 Sable 8861	<b>B</b> 831651 Bleu Nuit 2161
<b>A</b> 831472 Blanc Cassé 1103	<b>A</b> 831653 Beige Sable 2135	<b>A</b> 835261 Caramel 50261
<b>A</b> 831272 Nuage 50272	<b>A</b> 831654 Noir 8450	<b>B</b> 831848 Tilleul 50848
<b>A</b> 831850 Taupe 50850	<b>A</b> 831843 Karité 50843	<b>B</b> 831847 Acapulco 50847
<b>B</b> 831845 Auréoline 50845	<b>A</b> 831453 Bronze 2043	<b>B</b> 831851 Atlantique 50851
<b>B</b> 831846 Citrus 50846	<b>B</b> 831849 Jungle 50849	<b>A</b> 831844 Platine 50844

### SOLTIS W96 PROOF

Laize : 267 cm, longueur : 35 m / Width: 267 cm, length: 35 m

<b>A</b> 831671 Blanc 8102	<b>A</b> 831673 Anthracite 2047	<b>A</b> 831675 Galet 2171
<b>A</b> 831672 Crème 1103	<b>A</b> 831674 Vanille 8861	



	SOLTIS LOUNGE 96	SOLTIS W96 PROOF
<b>Description / Description</b>	Polyester	Polyester
<b>Enduction / Induction</b>	PVC	PVC
<b>Largeur / Width</b>	267 cm	267 cm
<b>Poids / Weight</b>	400 g/m <sup>2</sup>	620 g/m <sup>2</sup>
<b>Epaisseur / Thickness</b>	220/220 daN/5 cm	220/220 daN/5 cm
<b>Coefficient ouverture / Opening ratio</b>	5 %	5 %
<b>Résistance au Feu / Fire resistance</b>	M2	M2

**Protection solaire**

**SOLTIS**

**SOLTIS HARMONY 88**

Largeur : **PL = 177 cm**. Longueur : 50 m / Width: **PL = 177 cm**. Length: 50 m

Largeur : **GL = 267 cm**. Longueur : 40 m / Width: **GL = 267 cm**. Length: 40 m

<p><b>A</b></p> <p>PL 833000PL GL 833000 Blanc 2044</p>	<p><b>A</b></p> <p>PL 833007PL GL 833007 Champagne 2175</p>	<p><b>B</b></p> <p>PL 833012PL Bambou 50333</p>
<p><b>A</b></p> <p>PL 833001PL GL 833001 Galet 2171</p>	<p><b>A</b></p> <p>PL 833006PL GL 833006 Beige Sable 2135</p>	<p><b>B</b></p> <p>PL 833013PL Abricot 50332</p>
<p><b>A</b></p> <p>PL 833002PL GL 833002 Alu 2048</p>	<p><b>A</b></p> <p>PL 833008PL GL 833008 Chanvre 50265</p>	<p><b>B</b></p> <p>PL 833014PL Paprika 50308</p>
<p><b>A</b></p> <p>PL 833003PL GL 833003 Béton 2167</p>	<p><b>A</b></p> <p>PL 833009PL GL 833009 Poivre 2012</p>	<p><b>B</b></p> <p>PL 833015PL Bermudes 50306</p>
<p><b>A</b></p> <p>PL 833004PL GL 833004 Anthracite 2047</p>	<p><b>A</b></p> <p>PL 833010PL GL 833010 Cendre 50329</p>	<p><b>B</b></p> <p>PL 833016PL Figue 50335</p>
<p><b>A</b></p> <p>PL 833005PL GL 833005 Noir 2053</p>	<p><b>A</b></p> <p>PL 833011PL GL 833011 Bronze 2043</p>	

SOLTIS HARMONY 88	
Description / Description	Polyester Hte Tenacité
Résistance / Resistance	145/145 daN/5 cm
Poids / Weight	360 g/m <sup>2</sup>
Classement / Fire resistance	M1

**SOLTIS OPAQUE B99**

Largeur : 177 cm. Longueur : 40 m / Width: 177 cm. Length: 40 m

<p><b>A</b></p> <p>834300 Blanc 50348</p>	<p><b>A</b></p> <p>834303 Ecume 50284</p>	<p><b>A</b></p> <p>834306 Alu 50358</p>
<p><b>A</b></p> <p>834301 Quartz 50285</p>	<p><b>A</b></p> <p>834304 Gris clair 50613</p>	<p><b>A</b></p> <p>834307 Gris moyen 50354</p>
<p><b>B</b></p> <p>834302 Chanvre 50287</p>	<p><b>B</b></p> <p>834305 Argile 50288</p>	<p><b>A</b></p> <p>834308 Anthracite 50614</p>

SOLTIS OPAQUE B99	
Description / Description	Polyester Hte Tenacité
Résistance / Resistance	160/170 daN/5 cm
Poids / Weight	540 g/m <sup>2</sup>
Classement / Fire resistance	B1

## //// SUNWORKER

/// Largeur : **150 cm - L = 300 cm**. Rouleau de 60 m

Poids : 320 g/m<sup>2</sup>, classement M1, Polyester HT enduit PVC.

/ Widths: 150 cm - L = 300 cm. Rol of 60m. Weight: 320 g/m<sup>2</sup>, classification M1, Polyester HT coated with PVC.



980000		980006		980014	
980000L	Taupe M719	980006L	Silver M652	980014L	Beige M712
980001		980008		980015	
980001L	Elephant M939	980008L	Indigo M722	980015L	Champagne M711
980002		980009		980016	
980002L	Pearl M006	980009L	Charcoal M392	980016L	Cookie M718
980003		980010		980018	
980003L	White M005	980010L	Bison M715	980018L	Terra M720
980004		980011		980013	
980004L	Grey M654	980011L	Turf M717	980013L	Black M391
980005					
980005L	Iron M653				

/// Versions M2 : **Top** (imperméable) - largeur : 296 cm et **Open** - largeur : 305 cm - Sur demande.



**Protection solaire**

**SOLTIS**

**SOLTIS VEOZIP**

Largeur : **290 cm x 42 ml - L = 320 cm x 35 ml**. Uniquement au rouleau. Poids : 600 g/m<sup>2</sup>, classement M1, à base de chanvre  
 / Widths: 290 cm x 42 ml - L = 320 cm x 35 ml. Full roll only. Weight: 600 g/m<sup>2</sup>, classification M1, hemp-based.

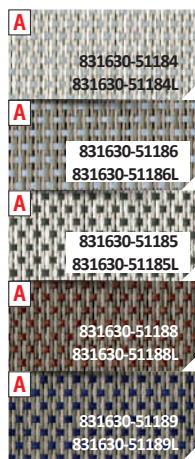

Blanc Givré 51184  
 Cumuls 51186  
 Edelweiss 51185  
 Macadamia 51188  
 Mistral 51189



Naturel 51187  
 Noir Graphite 51198  
 Ombre 51194  
 Otarie 51192  
 Oursin 51193

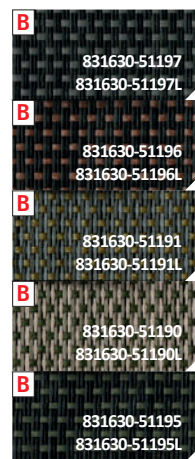

Poivre Gris 51197  
 Santal 51196  
 Terre de Lune 51191  
 Tundra 51190  
 Volcan 51195



SOLTIS VEOZIP	
Description / Description	À base de chanvre
Résistance / Resistance	250/170 daN/5 cm
Poids / Weight	600 g/m <sup>2</sup>
Classement / Fire resistance	M1 - B1





# Filet de liaison / Net - Trampoline

## FILET DE LIAISON / Net - Trampoline

Filet polyester traité anti UV maille losange 30 mm, double fil de Ø 3.5 mm Blanc. Ralingué avec bout Ø 8 mm  
 3 torons polyester / Polyester net anti UV. 30 x 30 square double thread Ø 3.5 mm. White. Border with roped 8 mm



Vous devez impérativement, nous fournir le plan coté de la surface à lier (trou) / You must provide the drawing of the link surface (hole).

<b>Réf.</b>	<b>Désignation</b>
831160	Filet de Liaison 30x30 Blanc ou Noir

**Rappel**  
 Trou : Côte entre flotteurs  
 / Hole: Dimension between float  
 Marge : 50 mm à 150 mm (selon choix client)  
 / Border: 50 mm to 150 mm (according to custom choice)  
 Décôte : 5 % élasticité pour tension  
 / Less dimension: 5 % of stretching for tension

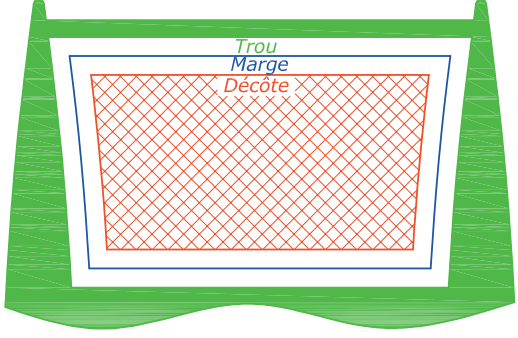

### IMPORTANT !

Pour réaliser votre filet de liaison / To produce your net  
 Renseigner les côtes (A, B, C, ...) de la surface à lier / Give dimensions (A, B, C, ...) of the surface to link (hole)

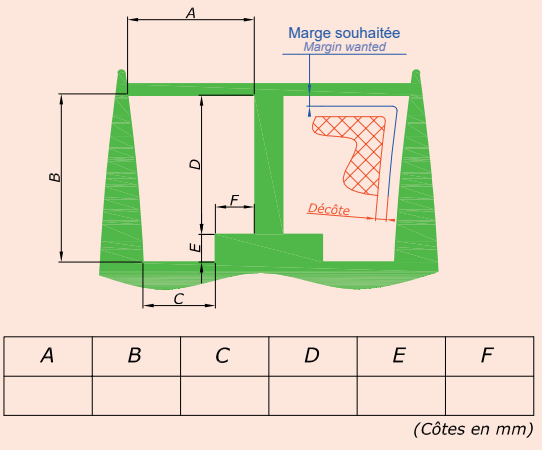
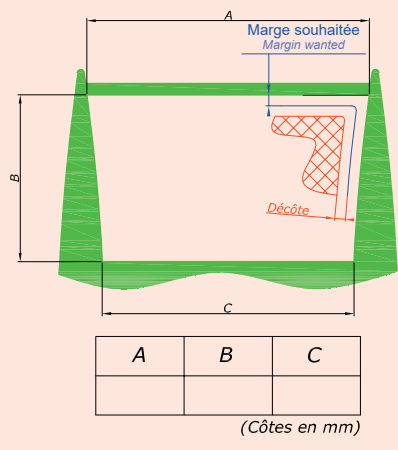

## Grilles / Meshes

### GRILLE FOND DE SAC / COUSSINS / End bag / cushions

Laize : 200 cm. Longueur : 50 m. 220 gr/m<sup>2</sup> / Width: 200 cm. Length: 50 m. 220 gr/m<sup>2</sup>

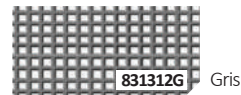
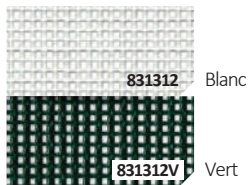

### PRECONTRAIT PROTECT / Prestressed protect

**Serge Ferrari**

#### PRECONTRAIT 332

Grille Précontraint 332. Laize : 267 cm, longueur : 50 m / Width: 267 cm, length: 50 m  
Pour brise vent, brise vue, bâchage aéré, grille de protection / For windbreak, view break, ventilated cover, protection grid



+ Autres couleurs / Other colors

#### PRECONTRAIT 362

Grille Précontraint 362. Laize : 267 cm, longueur : 50 m / Width: 267 cm, length: 50 m  
Pour brise vent, brise vue, bâchage aéré, grille de protection / For windbreak, view break, ventilated cover, protection grid

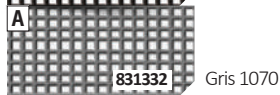
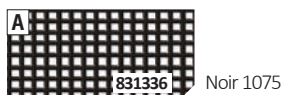

Sur commande / On order

## PRECONTRAIT 392

**Serge Ferrari**

Grille Précontraint 392. Laize : 180 cm, longueur : 50 m / Width: 180 cm, length: 50 m  
Pour brise vent, brise vue, bâchage aéré, grille de protection / For windbreak, view break, ventilated cover, protection grid

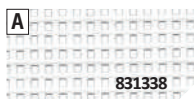

Blanc 392-100S2

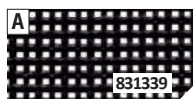

Noir 392-1075

## PRECONTRAIT 492

Grille Précontraint 492. Laize : 180 cm, longueur : 50 m / Width: 180 cm, length: 50 m  
Trampoline, grille de protection / Net, protection grid



Blanc 492-100S2

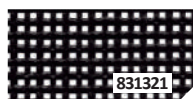

Noir 492-1075 

 Fabrication spéciale



Tissus outdoor & indoor / Outdoor & indoor Fabrics



	PRECONTRAIT 332	PRECONTRAIT 362	PRECONTRAIT 392	PRECONTRAIT 492
Fil / Thread	1100 dtex PES HT	1100 dtex PES HT	1100 dtex PES HT	3300 dtex PES HT
Poids / Weight	340 g/m <sup>2</sup>	430 g/m <sup>2</sup>	820 g/m <sup>2</sup>	1050 g/m <sup>2</sup>
Largeur / Width	267 cm	267 cm	180 cm	180 cm
Résistance rupture / Breakage resistance	230/150 daN/5 cm	250/270 daN/5 cm	300/300 daN/5 cm	500/500 daN/5 cm
Porosité / Porosity	± 14 %	± 28 %	± 27 %	± 31 %
Réaction au feu / Fire resistance	M1	M2	M2	M2
Efficacité au vent / Wind efficiency	92 %	80 %	81 %	78 %
Temp. extrêmes / Temp. resistance	- 30° C / +70° C	- 30° C / +70° C	- 30° C / +70° C	- 30° C / +70° C

**Mobilier, coussinage & vaigrage**



Tissus acrylique / Acrylics fabrics

SUNBRELLA Coussins / Cushions in & out

**SOLID & STRIPES - 260g/m<sup>2</sup>**

Laize : 137 cm, longueur : 50 m / Width: 137 cm, length: 50 m

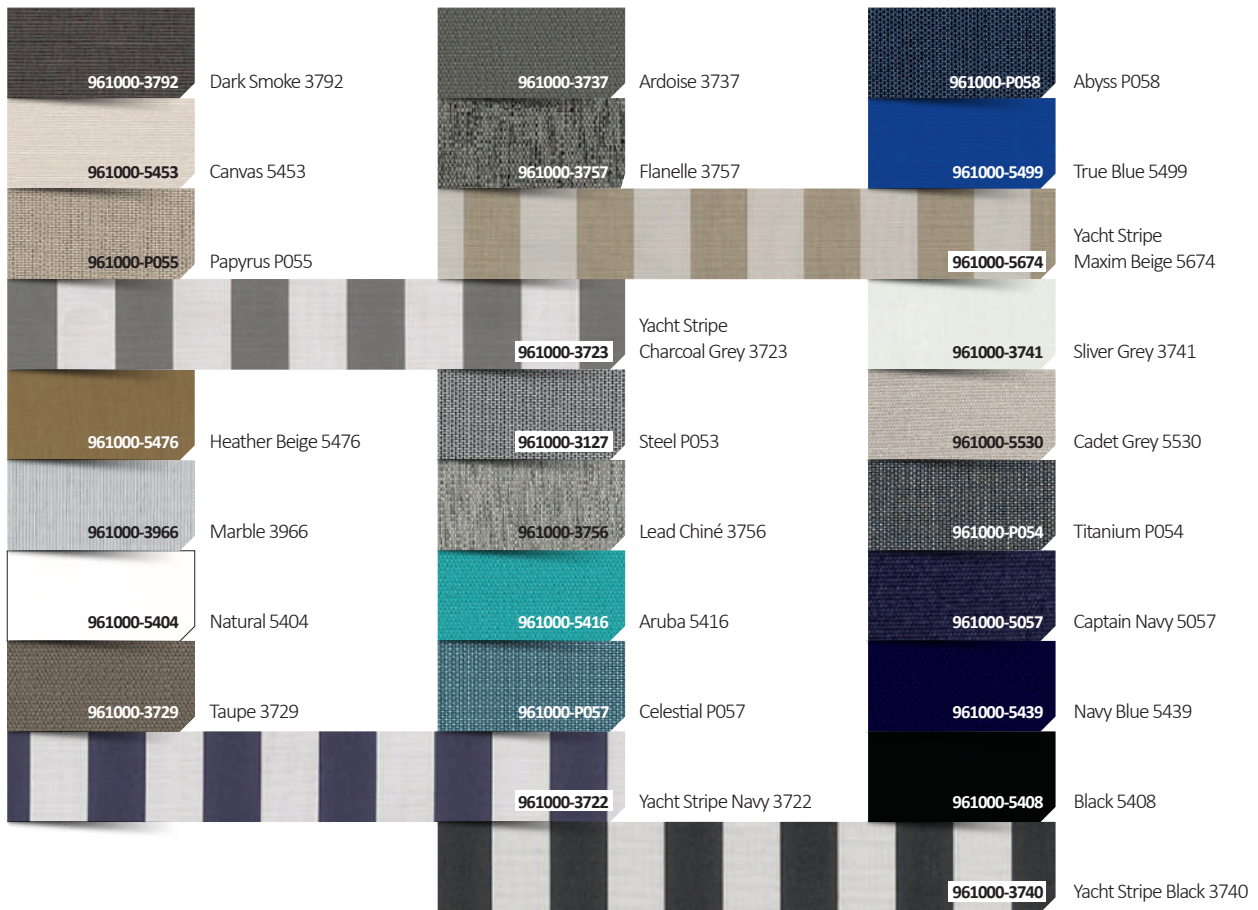

961000 Solid & Stripes  
 961001 Solid & Stripes Premium



//// SUNBRELLA Coussins / Cushions in & out



↳ SOLID & STRIPES - 260g/m<sup>2</sup>

/// Laize : 137 cm, longueur : 50 m / Width: 137 cm, length: 50 m

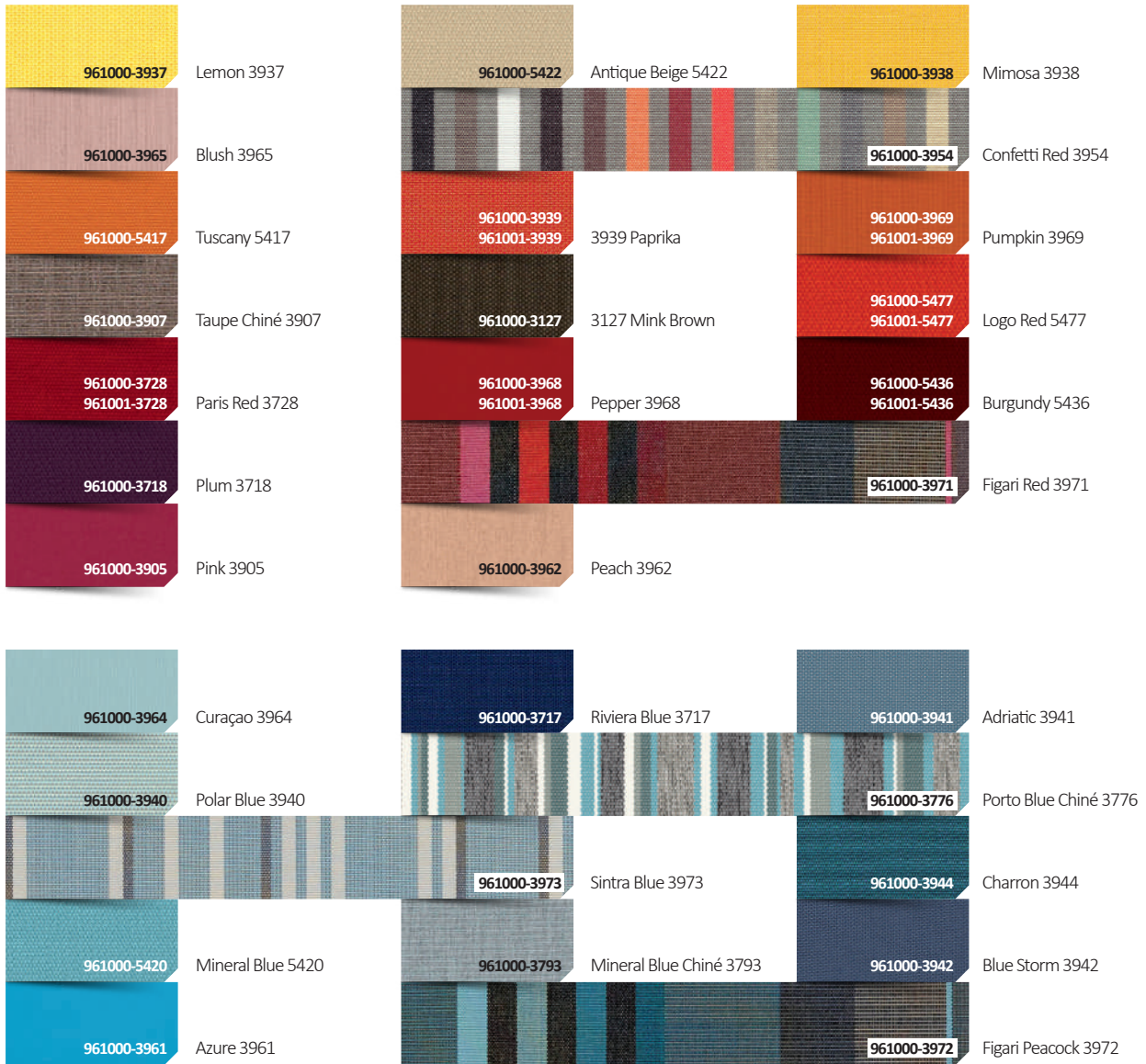

961000 Solid & Stripes  
961001 Solid & Stripes Premium

**Mobilier, coussinage & vaigrage**



Tissus acrylique / Acrylics fabrics

SUNBRELLA Coussins / Cushions in & out

**SOLID & STRIPES - 260g/m<sup>2</sup>**

Laize : 137 cm, longueur : 50 m / Width: 137 cm, length: 50 m

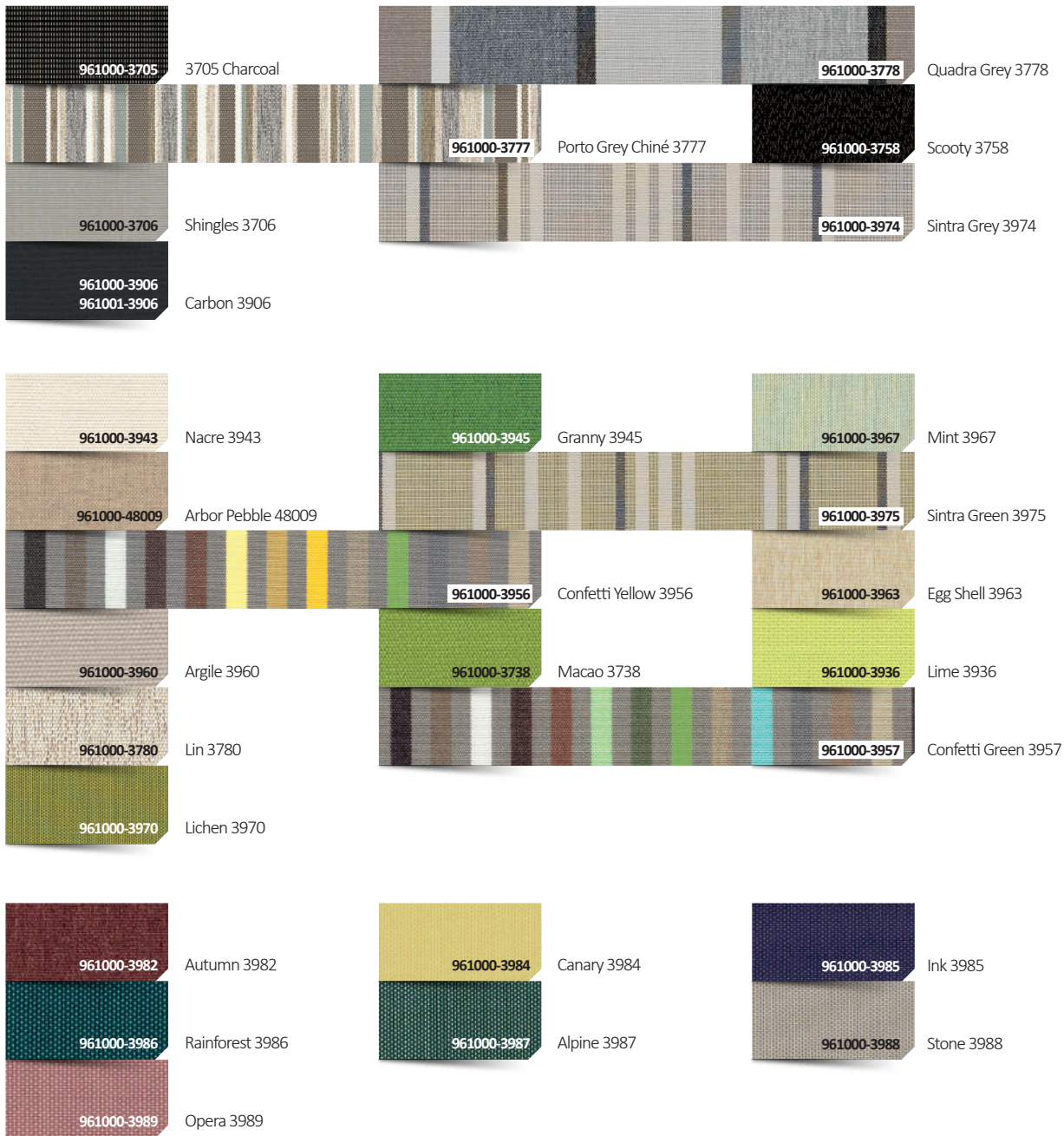

961000 Solid & Stripes  
 961001 Solid & Stripes Premium



////// **SUNBRELLA Coussins** / *Cushions in & out*



↳ **NATTE**

/// Laize : 140 cm, longueur : 50 m. 275 gr/m<sup>2</sup> / *Width: 140 cm, length: 50 m. Weight: 275 gr/m<sup>2</sup>*

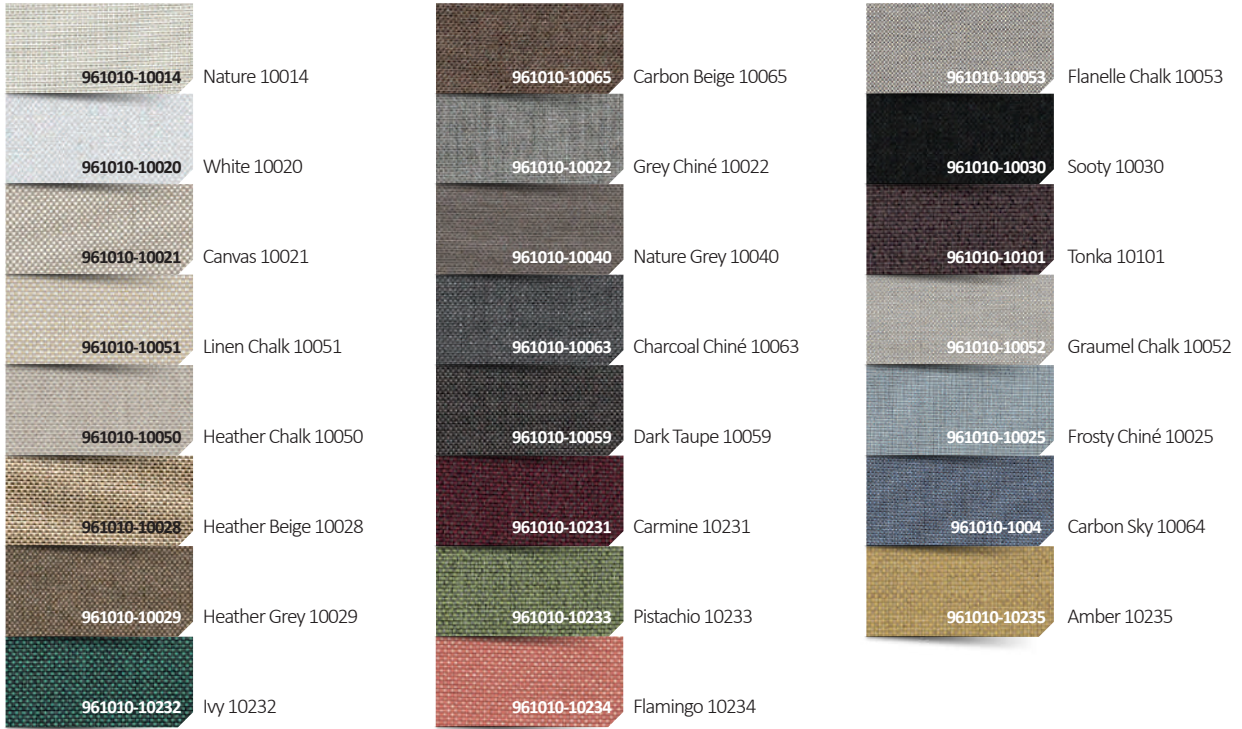

961010

NATTE

Tissus outdoor & indoor / Outdoor & indoor Fabrics



**Mobilier, coussinage & vaigrage**



Tissus acrylique / Acrylics fabrics

**SUNBRELLA Coussins / Cushions in & out**

**VELUM**

Laize : 300 cm, rouleau : 40 m. 165 gr/m<sup>2</sup> / Width: 300 cm, roll: 40 m. Weight: 165 gr/m<sup>2</sup>



961014-2003 Graumel 2003

961014x-2022 XI Barber 2022

961014x-2027 XI Concrete 2027

961014x-2002 XI Heather 2002

961014x-2021 XI Night 2021

961014x-2034 XI Swell 2034

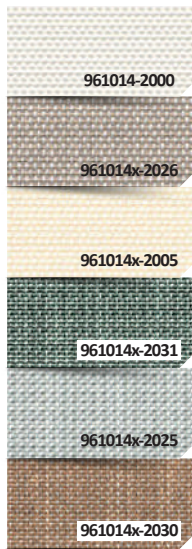

961014-2000 Natural 2000

961014x-2026 XI Beechwood 2026

961014x-2005 XI Creme White 2005

961014x-2031 XI Lichen 2031

961014x-2025 XI Polar 2025

961014x-2030 XI Tan 2030

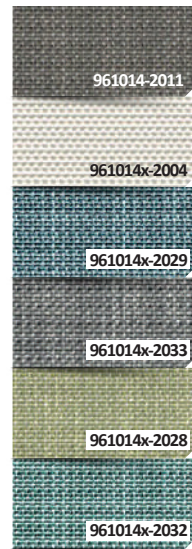

961014-2011 Nature Grey 2011

961014x-2004 XI Caillou 2004

961014x-2029 XI Fjord 2029

961014x-2033 XI Mouse 2033

961014x-2028 XI Sulfur 2028

961014x-2032 XI Wave 2032

961014	VELUM
961014X	VELUM

**CHARTRES**

Laize : 140 cm, longueur : 50 m. 375 gr/m<sup>2</sup> / Width: 140 cm, length: 50 m. Weight: 375 gr/m<sup>2</sup>



961003-J193 Pearl J193

961003-J194 Silver J194

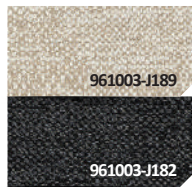

961003-J189 Heather J189

961003-J182 Sooty J182



961003-J191 Grey J191

961003-J348 Grey J348

961003	CHARTRES
--------	----------





//// **SUNBRELLA Coussins** / *Cushions in & out*



↳ **SAVANE**

/// Laize : 140 cm, longueur : 50 m. 400 gr/m<sup>2</sup> / *Width: 140 cm, length: 50 m. Weight: 400 gr/m<sup>2</sup>*

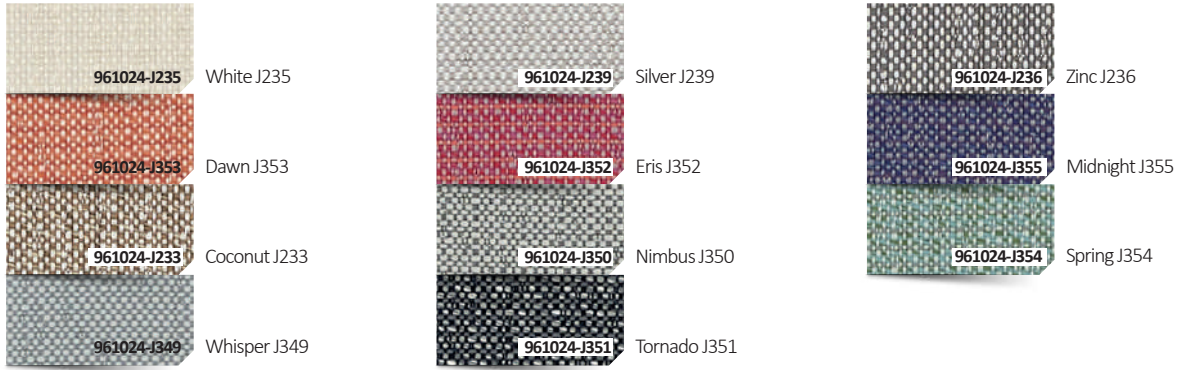

961024 SAVANE

↳ **LOPI**

/// Laize : 140 cm, longueur : 25 m. 680 gr/m<sup>2</sup> / *Width: 140 cm, length: 25 m. Weight: 680 gr/m<sup>2</sup>*



961026 LOPI



## Mobilier, coussinage & vaigrage



Tissus acrylique / Acrylics fabrics

### SUNBRELLA Coussins / Cushions in & out

#### SLING

Laize : 137 cm, longueur : 40 m. 480 gr/m<sup>2</sup> (Logan)\* / Width: 137 cm, length: 40 m. Weight: 480 gr/m<sup>2</sup> (Logan)\*

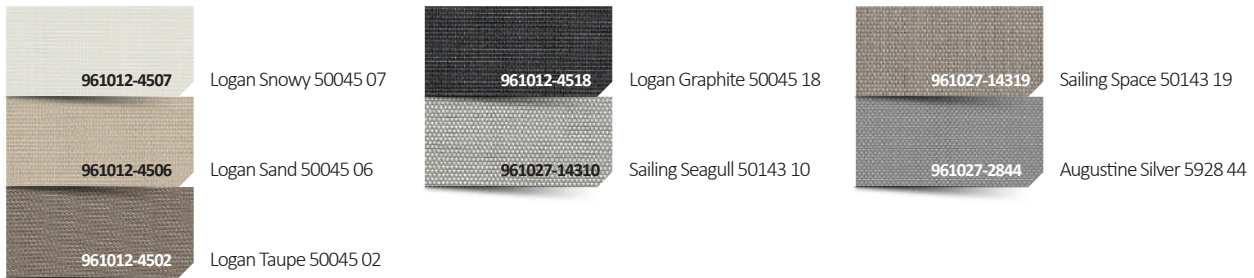

\* Existe en 580 gr/m<sup>2</sup> (Sailing) et 505 gr/m<sup>2</sup> (Augustine) / 580 gr/m<sup>2</sup> (Sailing) and 505 gr/m<sup>2</sup> (Augustine)

#### DEAUVE

Laize : 140 cm, longueur : 50 m. 335 gr/m<sup>2</sup> / Width: 140 cm, length: 50 m. Weight: 335 gr/m<sup>2</sup>



961005 DEAUVE

#### HERITAGE

Laize : 137 cm, longueur : 55 m. 335 gr/m<sup>2</sup> / Width: 137 cm, length: 55 m. Weight: 335 gr/m<sup>2</sup>



961028 HERITAGE



////// **SUNBRELLA Coussins / Cushions in & out**



↳ **ARCHI**

/// Laize : 140 cm, longueur : 25 m. 585 gr/m<sup>2</sup> / Width: 140 cm, length: 25 m. Weight: 585 gr/m<sup>2</sup>

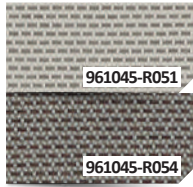

961045-R051 Frame R051

961045-R054 Ipe R054

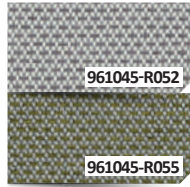

961045-R052 Concrete R052

961045-R055 Oxide R055

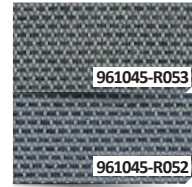

961045-R053 Lead R053

961045-R056 Slate R056

961045

ARCHI

↳ **RELAX**

/// Laize : 150 cm, longueur : 60 m. 208 gr/m<sup>2</sup> / Width: 150 cm, length: 60 m. Weight: 208 gr/m<sup>2</sup>



961046-B100 Cloud B100

961046-B113 Storm B113



961046-B101 Birch B101

961046-B118 Stone B118



961046-B102 Sand B102

961046-B119 Graphite B119

961046

RELAX

↳ **MAJESTIC**

/// Laize : 140 cm, longueur : 40 m. 410 gr/m<sup>2</sup> / Width: 140 cm, length: 40 m. Weight: 410 gr/m<sup>2</sup>

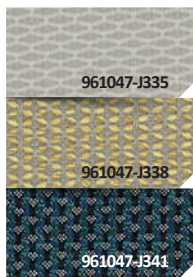

961047-J335 Jager J335

961047-J338 Citrine J338

961047-J341 Naos J341



961047-J336 River J336

961047-J339 Quartz J339

961047-J342 Amethyst J342

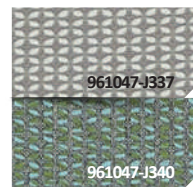

961047-J337 Crystal J337

961047-J340 Paraiba J340

961028

MAJESTIC

↳ **KOMO**

/// Laize : 150 cm, longueur : 60 m. 208 gr/m<sup>2</sup> / Width: 150 cm, length: 60 m. Weight: 208 gr/m<sup>2</sup>



961049-J343 Vetiver J343

961049-J346 Coua J346



961049-J344 Peat J344

961049-J347 Raffia J347



961049-J345 Tawny J345

961049

KOMO



**Mobilier, coussinage & vaigrage**



//// Tissus acrylique / Acrylics fabrics

//// **SUNBRELLA Coussins / Cushions in & out**

L> **MEZZO**

/// Laize : 140 cm, longueur : 50 m. 285 gr/m<sup>2</sup> / Width: 140 cm, length: 50 m. Weight: 285 gr/m<sup>2</sup>

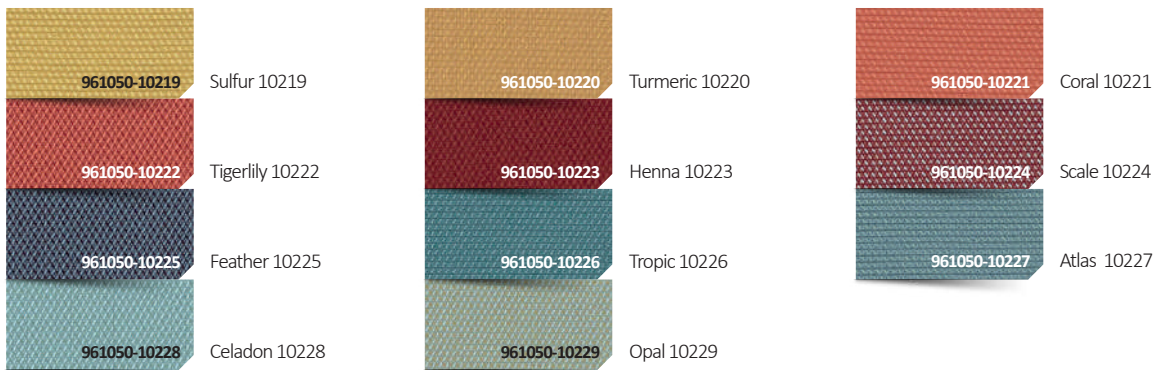

961050 MEZZO

L> **MARQUETRY**

/// Laize : 140 cm, longueur : 25 m. 600 gr/m<sup>2</sup> / Width: 140 cm, length: 25 m. Weight: 600 gr/m<sup>2</sup>



961051 MARQUETRY

L> **DOMINO**

/// Laize : 140 cm, longueur : 25 m. 630 gr/m<sup>2</sup> / Width: 140 cm, length: 25 m. Weight: 630 gr/m<sup>2</sup>



961005 DOMINO



////// **SUNBRELLA Coussins / Cushions in & out**



↳ **IKEBANA**

/// Laize : 140 cm, longueur : 25 m. 525 gr/m<sup>2</sup> / Width: 140 cm, length: 25 m. Weight: 525 gr/m<sup>2</sup>

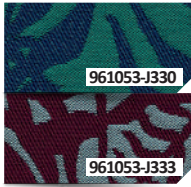

961053-J330 Canopy J330

961053-J333 Polar J333



961053-J331 Bayou J331

961053-J334 Canyon J334

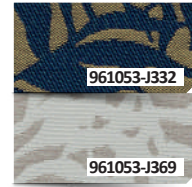

961053-J332 Safari J332

961053-J369 Uyuni J369

961053 IKEBANA

↳ **FOUTAH**

/// Laize : 140 cm, longueur : 50 m. 275 gr/m<sup>2</sup> / Width: 140 cm, length: 50 m. Weight: 275 gr/m<sup>2</sup>



961054-3978 Pastis 3978

961054-3981 Petanque 3981



961054-3979 Cyclades 3979



961054-3980 Olive 3980

961054 FOUTAH

↳ **ZORI**

/// Laize : 140 cm, longueur : 30 m. 540 gr/m<sup>2</sup> / Width: 140 cm, length: 30 m. Weight: 540 gr/m<sup>2</sup>



961055-R057 Rice R057

961055-R060 Straw R060

961055-R063 Hibiscus R063

961055-R066 Sake R066

961055-R069 Miso R069



961055-R058 Washi R058

961055-R061 Gari R061

961055-R064 Kiri R064

961055-R067 Graphite R067

961055-R070 Muse R070



961055-R059 Matcha R059

961055-R062 Sento R062

961055-R065 Fugu R065

961055-R068 Nami R068

961055 ZORI



Mobilier, coussinage & vaigrage



Tissus polyester enduit / Coated polyester fabrics

STAMSKIN

STAMSKIN TOP F4340

Laize : 140 cm, longueur : 20 m / Width: 140 cm, length: 20 m

	831512 Blanc Marbre 10120		831509-20289 Olso 20289		831509-20278 Cognac 20278
	831509-5029 Sable 5029		831514 Taupe 07432		831509-20286 Alezan 20286
	831509-20279 Sahara 20279		831509-20294 Turquoise 20294		831511 Marine 10295
	831509-20291 Lichen 20291		831509-20299 Mimosa 20299		831509-202837 Sepia 20237
	831509-20300 Bambou 20300		831509-20281 Golden 20281		831509-20290 Baltic 20290
	831509-20296 Cactus 20296		831513 Chocolat 20129		831509-20288 Capri 20288
	831509-20241 Bonsaï 20241		831509-20280 Capucine 20280		831509-20284 Adriatic 20284
	833514 Gris Galet 07445		833509-20283 Bourgogne 20283		831509-20151 Platine 20151
	831515 Noir 00002		833523 Rouge Synabre 07478		831509-20295 Sari 20295
	831509-20253 Olive 20253		833524 Rouge Carmin 07479		831509-20287 Pivoine 20287
	831509-20282 Cèdre 20282		831509-20285 Havane 20285		831509-20293 Poudre 20293



STAMSKIN TOP F4340	
Composition / Composition	Composite multi-couche
Support / Support	Jersey Polyamide
Poids / Weight	780 g/m <sup>2</sup>
Largeur / Width	140 cm
Epaisseur / Thickness	0,8 - 1,00 mm
Résistance déchirure / Tear resistance	120 000 tours
Résistance abrasion / Abrasion resistance	6/8
Stabilité lumière / Light stability	-20 à +70° C
Normes Non Feu / Fire resistance	M2- IMO



## STAMSKIN

### STAMSKIN TOP CLUB

Serge Ferrari

Laize : 140 cm, longueur : 20 m / Width: 140 cm, length: 20 m



Tissus outdoor & indoor / Outdoor & indoor Fabrics

#### STAMSKIN TOP CLUB

<b>Composition / Composition</b>	Composite multi-couche
<b>Support / Support</b>	Jersey Polyamide
<b>Poids / Weight</b>	780 g/m <sup>2</sup>
<b>Largeur / Width</b>	140 cm
<b>Epaisseur / Thickness</b>	1,0 - 1,2 mm
<b>Résistance déchirure / Tear resistance</b>	120 000 tours
<b>Résistance abrasion / Abrasion resistance</b>	6/8
<b>Stabilité lumière / Light stability</b>	-20 à +70° C
<b>Normes Non Feu / Fire resistance</b>	M2- IMO

**Mobilier, coussinage & vaigrage**

//// Tissus polyester enduit / Coated polyester fabrics

//// **STAMSKIN**

↳ **STAMSKIN ZEN Avec Technologie anti bactérienne AGIVIR / With AGIVIR anti-bacterial technology**

/// Laize : 140 cm, longueur : 20 m / Width: 140 cm, length: 20 m

<b>B</b> 831600-10120 Blanc 10120	<b>B</b> 831600-20290 Baltique 20290	<b>C</b> 831600-20321 Vert Kaki 20321
<b>B</b> 831600-0002 Noir 0002	<b>B</b> 831600-5349 Aubergine 5349	<b>B</b> 831600-20322 Nude 20322
<b>C</b> 831600-07445 Gris Galet 07445	<b>B</b> 831600-20159 Bambou 20159	<b>B</b> 831600-7436 Bleu Foncé 7436
<b>C</b> 831600-07477 Maïs 07477	<b>C</b> 831600-20293 Poudre 20293	<b>B</b> 831600-20162 Coton 20162
<b>C</b> 831600-20127 Orange 20127	<b>C</b> 831600-20316 Lilas 20316	<b>B</b> 831600-20161 Brume 20161
<b>B</b> 831600-07459 Bleu Brillant 07459	<b>C</b> 831600-20157 Turquoise 20157	<b>B</b> 831600-20154 Granit 20154
<b>C</b> 831600-07479 Rouge Carmin 07479	<b>C</b> 831600-20319 Coquelicot 20319	<b>B</b> 831600-20150 Cendre 20150
<b>C</b> 831600-20149 Fushia 20149	<b>C</b> 831600-20320 Foret 20320	<b>B</b> 831600-5015 Café 5015



<b>STAMSKIN ZEN</b>	
<b>Composition / Composition</b>	Composite multi-couche
<b>Support / Support</b>	Jersey Polyester
<b>Poids / Weight</b>	780 g/m <sup>2</sup>
<b>Largeur / Width</b>	140 cm
<b>Résistance rupture / Breakage resistance</b>	28/44 daN/5 cm
<b>Résistance abrasion / Abrasion resistance</b>	120 000 cycles
<b>Températures extrêmes / Temperature resistance</b>	- 20° C / + 70° C
<b>Normes Non Feu / Fire resistance</b>	M2





**MORBERN**

**SUNDANCE MGX**

Laize : 137 cm, longueur : 36 m. Nouveau support polyester 100% recyclé  
/ Width: 137 cm, length: 36 m. New 100% recycled polyester backing



858701	White 701	858709	Red 709	858726	Submarine 726
858703	Natural 703	858710	Cayenne 710	858731	Sangria 731
858704	Khaki 704	858711	Bisque 711	858725	Siesta Key 725
858708	Herm 708	858713	Rain 713	858733	Rhino 733
858712	Chocolate 712	858714	Ocean 714	858723	Cornsilk 723
858715	Sand 715	858717	Green 717	858729	Chartreuse 729
858716	Storm 716	858718	Marine 718	858728	Pineapple 728
858719	Blue 719	858720	Black 720	858727	Periwinkle 727
858702	Silver 702	858721	Valley 721	858732	Sahara 732
858705	Crush 705	858722	Acadia 722	858735	Nightfall 735
858706	October 706	858724	Cumulus 724	858734	Spruce 734
858707	Bamboo 707	858736	Raven 736	858730	Rose 730
858737	Caramel 737	858740	Celadon 740	858742	Umber 742
858738	Ash 738	858741	Fossil 741	858743	Asphalt 743
858739	Raspberry 739				

Tissus outdoor & indoor / Outdoor & indoor Fabrics

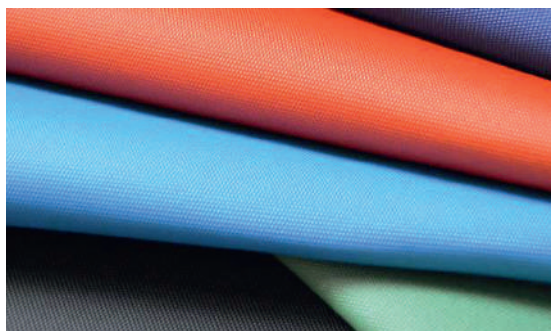

SUNDANCE MGX	
Composition / Composition	Vynil expansé
Poids / Weight	695 gr
Largeur / Width	137 cm
Longueur pièce / Length	28 m
Epaisseur / Thickness	1,2 mm
Résistance abrasion (nombre de cycles / martindale) / Abrasion resistance	>300 000
Normes Non Feu / Fire resistance	M2
Résistance UV (Blue wool scale / max 8) / UV Resistance	>7

## Mobilier, coussinage & vaigrage

### MORBERN

#### PRODIGY

Laize : 137 cm, longueur : 36 m. Nouveau support polyester 100% recyclé / Width: 137 cm, length: 36 m. New 100% recycled polyester backing

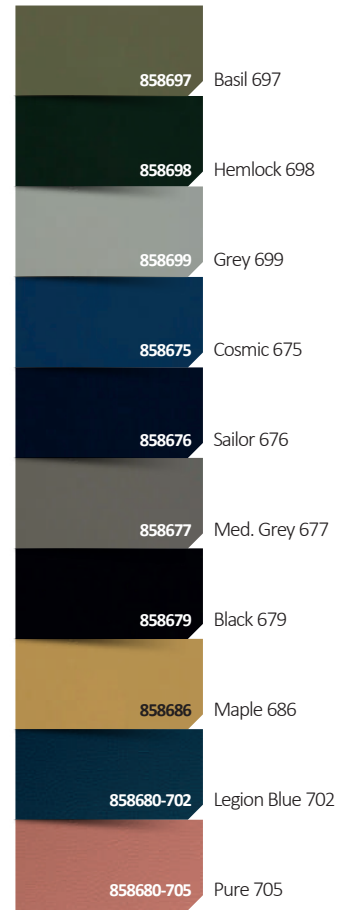

#### SAND PIPER

Laize : 137 cm, longueur : 28 m. Avec support bi-élastique / Width: 137 cm, length: 28 m. With bi-elastic support



	PRODIGY	SANDPIPER
<b>Composition / Composition</b>	Vynil expansé	Vynil expansé
<b>Poids / Weight</b>	695 gr	745 gr
<b>Largeur / Width</b>	137 cm	137 cm
<b>Longueur pièce / Length</b>	36 m	28 m
<b>Epaisseur / Thickness</b>	1,2 mm	+/- 1 mm
<b>Résistance abrasion (nombre de cycles / martindale) / Abrasion resistance</b>	>300 000	>250 000
<b>Normes Non Feu / Fire resistance</b>	M2	EN1021
<b>Résistance UV (Blue wool scale / max 8) / UV Resistance</b>	>7	EN1021



## //// MORBERN

### ↳ TOUCH

Laize : 137 cm, longueur : 28 m. Nouveau support polyester 100% recyclé  
 / Width: 137 cm, length: 28 m. New 100% recycled polyester backing

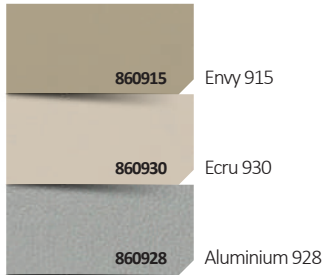

### ↳ CARRARA

Laize : 137 cm, longueur : 36 m. Nouveau support polyester 100% recyclé  
 / Width: 137 cm, length: 36 m. New 100% recycled polyester backing

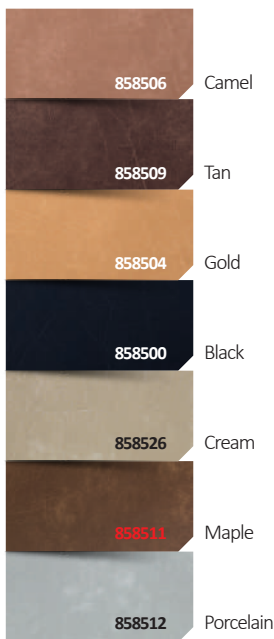

	TOUCH	CARRARA
<b>Composition / Composition</b>	Vynil expansé	Vynil expansé
<b>Poids / Weight</b>	725 gr (± 51) gr	661 gr
<b>Largeur / Width</b>	137 cm	137 cm
<b>Longueur pièce / Length</b>	28 m	36 m
<b>Epaisseur / Thickness</b>	1 mm	1 mm
<b>Résistance abrasion (nombre de cycles / martindale) / Abrasion resistance</b>	≥ 300 000	>300 000
<b>Normes Non Feu / Fire resistance</b>	M2	M2
<b>Résistance UV (Blue wool scale / max 8) / UV Resistance</b>	≥ 7	>7

## Mobilier, coussinage & vaigrage

### MORBERN

#### NATURAL LINEN

Laize : 137 cm, longueur : 28 m. Nouveau support polyester 100% recyclé  
/ Width : 137 cm, length : 28 m. New 100% recycled polyester backing



	885801 Pearl NL-001		885802 Tan NL-002		885803 Butter NL-003
	885804 Haystack NL-004		885805 Ganache NL-005		885806 Sunset NL-006
	885807 Burnt Orange NL-007		885808 Cayenne NL-008		885809 Potters Clay NL-009
	885810 Bamboo NL-010		885811 Grey NL-011		885812 Charcoal NL-012
	885813 Moss NL-013		885814 Storm NL-014		885815 Navy NL-015
	885816 Russet NL-016		885817 Sepia NL-017		885818 Berry NL-018
	885820 Maize NL-020		885821 Wheat NL-021		885822 Teal NL-022
	885823 Basil NL-023		885824 Olive NL-024		885825 Barley NL-025
	885826 Mocha NL-026				



NATURAL LINEN	
Composition / Composition	Vinyl expansé
Poids / Weight	695 gr
Largeur / Width	137 cm
Longueur pièce / Length	28 m
Epaisseur / Thickness	1 mm
Résistance abrasion (nombre de cycles / martindale) / Abrasion resistance	>300 000
Normes Non Feu / Fire resistance	M2
Résistance UV (Blue wool scale / max 8) / UV Resistance	>7

Sur commande / On order

## BATYLINE

### BATYLINE ISO 7407

Serge Ferrari

/// **Gamme standard** - Laize : 180 cm, longueur : 50 m / *Standard Sortiment* - Width: 180 cm, length: 50 m

<b>A</b>	831152	Neige 5001	<b>A</b>	831184-50866	Brique 50866	<b>A</b>	831153	Noir 5005
<b>A</b>	831164	Platine 5374	<b>A</b>	831163	Cendre 5014	<b>A</b>	831162	Acier 5003
<b>B</b>	831184-50881	Nuage 50881	<b>B</b>	831184-50886	Solaire 50886	<b>A</b>	831156	Chocolat 5048
<b>A</b>	831154	Crème 5029	<b>A</b>	831184	Lin 5378	<b>B</b>	831158	Navy 5006
<b>B</b>	831184-5017	Bouton d'Or 5017	<b>A</b>	831173	Encens 5376	<b>A</b>	831157	Souris 5004
<b>A</b>	831184-50865	Paon 50865	<b>B</b>	831165	Rouge 5011	<b>A</b>	831179	Atoll 5347
<b>B</b>	831184-50882	Noisette 50882	<b>A</b>	831144	Chataigne 50070	<b>A</b>	831169	Bleuet 5007
<b>A</b>	831184-50880	Amande 50880	<b>A</b>	831151	Taupe 5015	<b>A</b>	831167	Gris Anthracite 5700
<b>B</b>	831184-50885	Yucca 50885						



+

#### STANDARD

Poids / Weight	500 g/m <sup>2</sup>
Largeur / Width	180 cm
Porosité / Porosity	22 %
Résistance rupture (chaîne/trame) / Breakage resistance	240/240 daN/5 cm
Allongement sous charge 20 daN (chaîne/trame) / Elogation under load 20 daN	≤ 2.5 % / ≤ 2.5 %
Résistance abrasion / Abrasion resistance	>120 000 cycles
Températures extrêmes / Extreme temperature	-30°C / +70°C
Norme non feu / Fire resistance	M2

! Sur commande / On order

**Mobilier, coussinage & vaigrage**

**BATYLINE**

**BATYLINE ISO 7407**

**Sur demande** - Laize : 180 cm, longueur : 50 m / **On demand** - Width: 180 cm, length: 50 m **!**

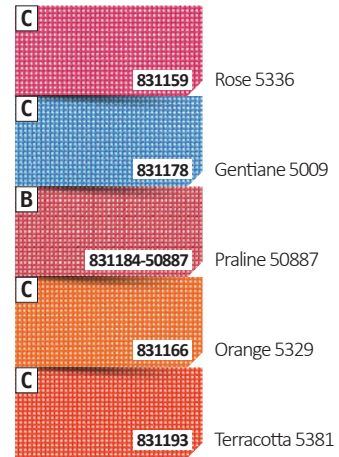
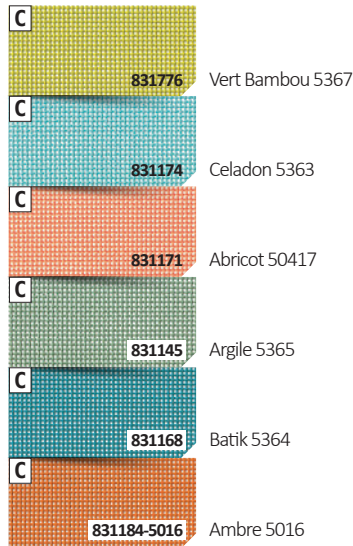
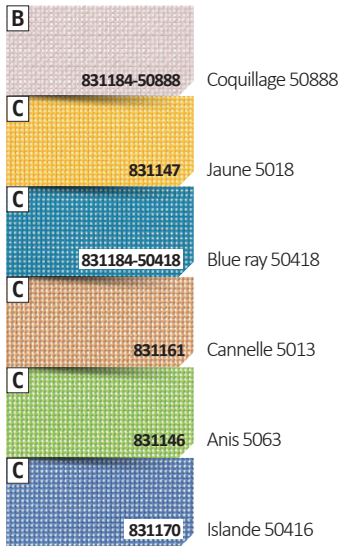

**Multicolore** - Laize : 180 cm, longueur : 50 m / **Multicolour** - Width: 180 cm, length: 50 m

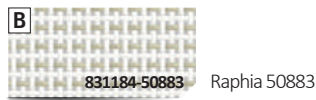

	<b>SUR DEMANDE</b>	<b>MULTICOLORE</b>
<b>Poids / Weight</b>	500 g/m <sup>2</sup>	500 g/m <sup>2</sup>
<b>Largeur / Width</b>	180 cm	180 cm
<b>Porosité / Porosity</b>	22 %	22 %
<b>Résistance rupture (chaîne/trame) / Breakage resistance</b>	240/240 daN/5 cm	240/240 daN/5 cm
<b>Allongement sous charge 20 daN (chaîne/trame) / Elogation under load 20 daN</b>	≤ 2.5 % / ≤ 2.5 %	≤ 2.5 % / ≤ 2.5 %
<b>Résistance abrasion / Abrasion resistance</b>	>120 000 cycles	>120 000 cycles
<b>Températures extrêmes / Extreme temperature</b>	- 30°C / + 70° C	- 30°C / + 70° C
<b>Norme non feu / Fire resistance</b>	M2	M2

**!** Sur commande / On order



Tissus outdoor & indoor / Outdoor & indoor Fabrics

Mobilier, coussinage & vaigrage

BATYLINE

BATYLINE ISO 7407FR

Laize : 180 cm, longueur : 50 m / Width: 180 cm, length: 50 m

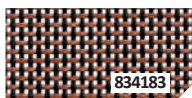

834183 Noir Cuivré 7407FR- 5266

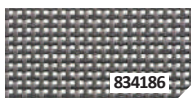

834186 Alu Clair 7407FR- 5260

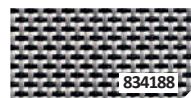

834188 Alu Métal 7407FR- 5261

BATYLINE ISO 7406

Laize : 180 cm, longueur : 50 m / Width: 180 cm, length: 50 m

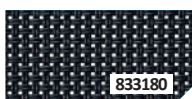

833180 7406-5005



	7407FR	7406
<b>Poids / Weight</b>	500 g/m <sup>2</sup>	660 g/m <sup>2</sup>
<b>Largeur / Width</b>	180 cm	180 cm
<b>Porosité / Porosity</b>	22 %	11 %
<b>Résistance rupture (chaîne/trame) / Breakage resistance</b>	240/240 daN/5 cm	360/330 daN/5 cm
<b>Allongement sous charge 20 daN (chaîne/trame) / Elongation under load 20 daN</b>	≤ 2.5 % / ≤ 2.5 %	≤ 2.5 % / ≤ 2.5 %
<b>Résistance abrasion / Abrasion resistance</b>	>120 000 cycles	>120 000 cycles
<b>Températures extrêmes / Extreme temperature</b>	- 30°C / + 70° C	- 30°C / + 70° C
<b>Norme non feu / Fire resistance</b>	M2	



## BATYLINE

Serge Ferrari

### BATYLINE DUO 7300

Laize : 180 cm, longueur : 50 m, poids : 560 gr / Width: 180 cm, length: 50 m, weight : 560gr

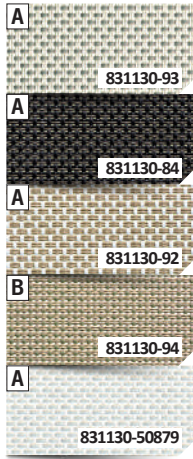

Ficelle 5393

Onyx 5384

Raphia 5392

Cassonade 5394

Perle 50879

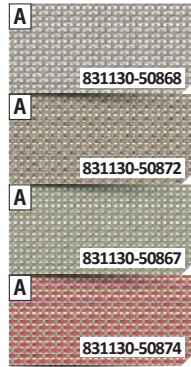

Ciment 50868

Cuir 50872

Avocat 50867

Sienne 50874

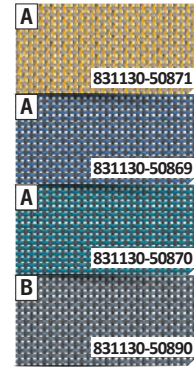

Gingembre 50871

Croisière 50869

Canard 50870

Tempête 50890

DUO

### BATYLINE DUO 7301 TWIST

Laize : 180 cm, longueur : 50 m, poids : 560 gr / Width: 180 cm, length: 50 m, weight : 560gr

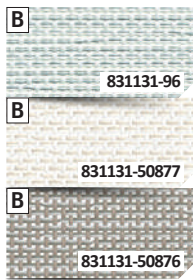

Ecume 5396 Twist

Silice 50877 Twist

Mineral 50876 Twist

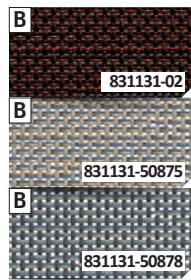

Espresso 5402 Twist

Moonstone 50875 Twist

Mica 50878 Twist

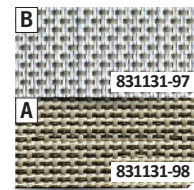

Nuage 5397 Twist

Cappuccino 5398 Twist

DUO M2

### BATYLINE DUO 7300FR

Laize : 180 cm, longueur : 50 m, poids : 560 gr / Width: 180 cm, length: 50 m

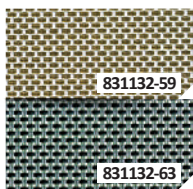

5559 FR

5563 FR



5001 FR



5005 FR

	7300/7301	7300FR
<b>Poids / Weight</b>	560 g/m <sup>2</sup>	560 g/m <sup>2</sup>
<b>Largeur / Width</b>	180 cm	180 cm
<b>Porosité / Porosity</b>	10 %	10 %
<b>Résistance rupture (chaîne/trame) / Breakage resistance</b>	240/210 daN/5 cm	240/210 daN/5 cm
<b>Allongement sous charge 20 daN (chaîne/trame) / Elongation under load 20 daN</b>	≤ 2 % / ≤ 3 %	≤ 2 % / ≤ 3 %
<b>Résistance abrasion / Abrasion resistance</b>	>120 000 cycles	>120 000 cycles
<b>Températures extrêmes / Extreme temperature</b>	- 30°C / + 70° C	- 30°C / + 70° C
<b>Norme non feu / Fire resistance</b>		M2

Non feu / M2

Tissus outdoor & indoor / Outdoor & indoor Fabrics

**Mobilier, coussinage & vaigrage**

**BATYLINE**

**BATYLINE EDEN 7710**

Laize : 180 cm, longueur : 50 m / Width: 180 cm, length: 50 m

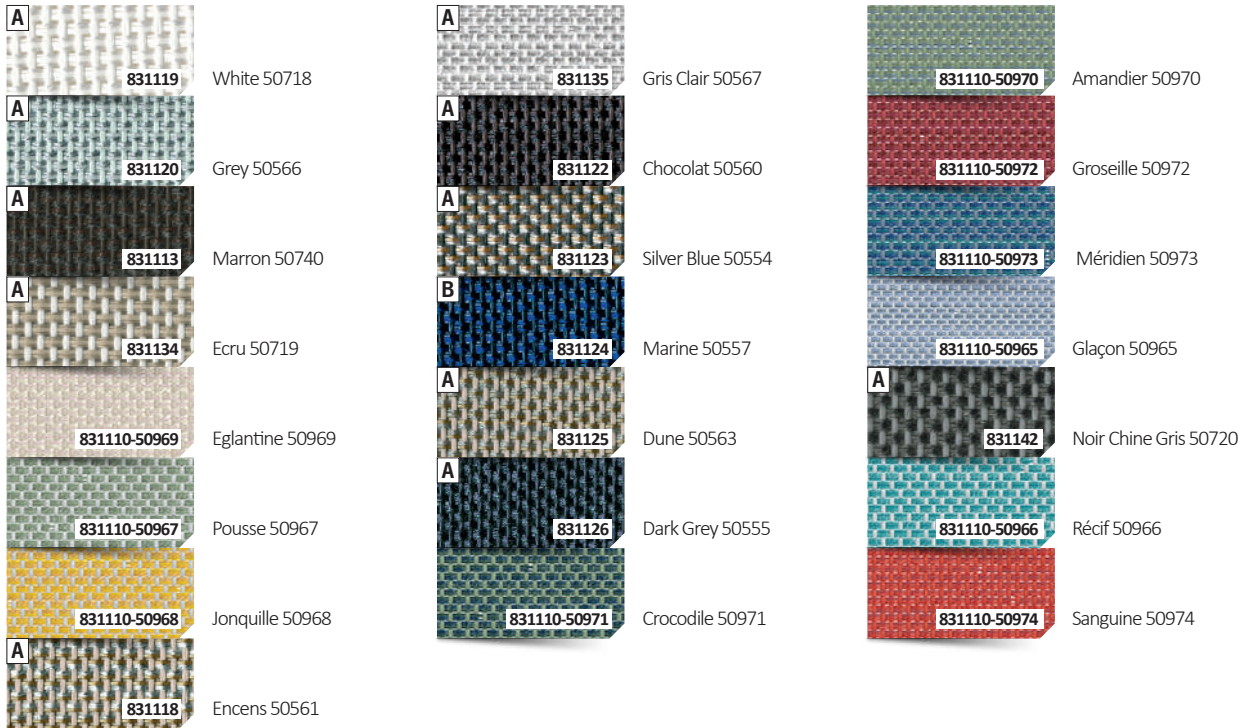

- /// Batyline EDEN " WP " disponible en 12 coloris / Batyline EDEN "WP" available in 12 colors ⓘ
- /// Batyline EDEN " FR " disponible en 35 coloris / Batyline EDEN "FR" available in 35 colors ⓘ

**BATYLINE ALPHALIA SILENT AW**

Laize : 270 cm, longueur : 40 m / Width: 270 cm, length: 40 m



ALPHA SILENT AW	
Poids / Weight	600 g/m <sup>2</sup>
Largeur / Width	270 cm
Porosité / Porosity	10 %
Résistance rupture (chaîne/trame) / Breakage resistance	250/220 daN/5 cm
Résistance aux micro-organismes / Micro-organism resistance	Degré 0, Excellent
Températures extrêmes / Extreme temperature	- 30° C / + 70° C
Norme non feu / Fire resistance	BS2DØ

	EDEN	EDEN WATERPROOF
Composition	Composite PVC	Composite PVC
Poids / Weight	450 g/m <sup>2</sup>	470 g/m <sup>2</sup>
Largeur / Width	180 cm	180 cm
Porosité / Porosity	8 %	
Résistance rupture (chaîne/trame) / Breakage resistance	240/150 daN/5 cm	240/150 daN/5 cm
Allongement sous charge 20 daN (chaîne/trame) / Elogation under load 20 daN	≤ 2.5 % / ≤ 4 %	≤ 2.5 % / ≤ 4 %
Résistance abrasion / Abrasion resistance	>50 000 cycles	>50 000 cycles
Températures extrêmes / Extreme temperature	- 30° C / + 70° C	- 30° C / + 70° C

Sur commande / On order

## BATYLINE

Serge Ferrari

### BATYLINE LOUNGE 7720FR

Laize : 180 cm, longueur : 50 m / Width: 180 cm, length: 50 m

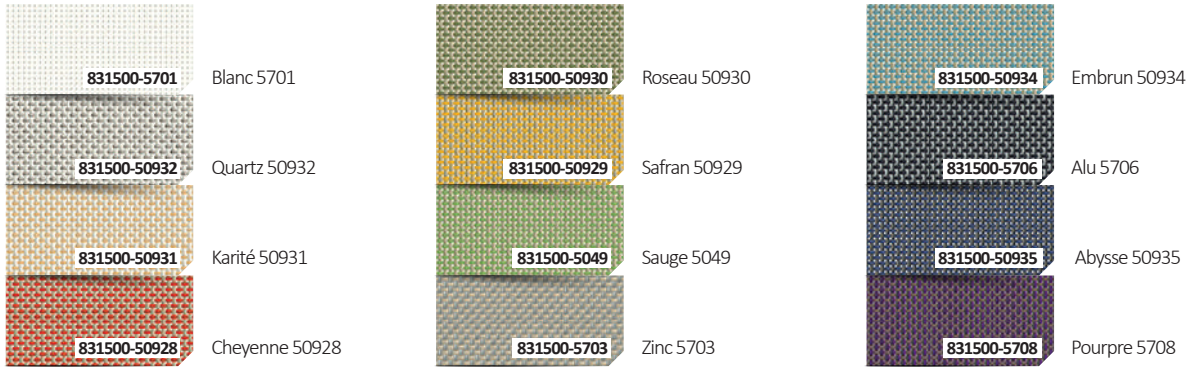

Batyline LOUNGE " WP " disponible / Batyline LOUNGE "WP" available !

### BATYLINE ELIOS 7740

Laize : 140 cm, longueur : 50 m / Width: 140 cm, length: 50 m

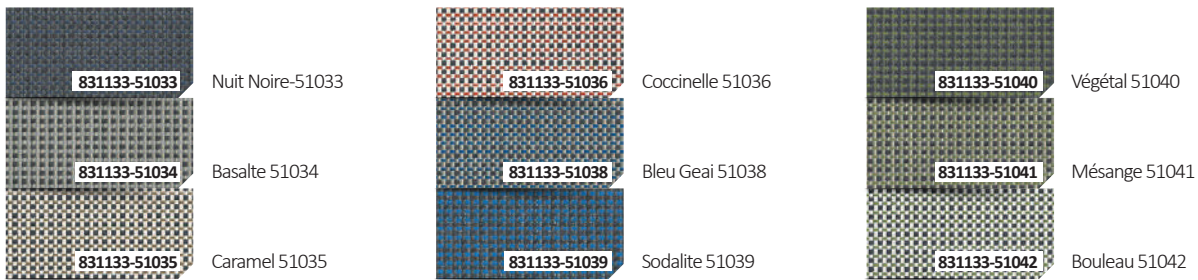

LOUNGE



BATYLINE ELIOS 7740

	LOUNGE 7720FR	ELIOS 7740
Poids / Weight	500 g/m <sup>2</sup>	450 g/m <sup>2</sup>
Largeur / Width	180 cm	140 cm
Porosité / Porosity	10 %	10 %
Résistance rupture (chaîne/trame) / Breakage resistance	150/150 daN/5 cm	160/100 daN/5 cm
Résistance aux micro-organismes / Micro-organism resistance	Méthode A, Excellent	Excellent, ISO 846-A
Températures extrêmes / Extreme temperature	- 30° C / + 70° C	- 10° C / + 70° C
Norme non feu / Fire resistance	M2	IMO MSC.307

Sur commande / On order

## Mobilier, coussinage & vaigrage

### VAIGRAGE SUR FEUTRINE / Headliner fabric

#### PVC SUR FEUTRINE / PVC headliner

Coaguilleté NT-PU enduit de PVC. Enduction : 83 % PVC / 2 % VA. Support : 13 % PES / 2 % PU. Traitement antimoisissures Biopruf. Laize de 135-140 cm, rouleau de 25m.

Co-needleloom PVC coating. Enduction: 83 % PVC / 2 % VA. Support: 13 % PES / 2 % PU. Anti mold treatment Biopruf. Width: 135 -140 cm, roll of 25m.

186471	Chevreau blanc* ML
186474	Dollaro blanc* ML
186483	Dollaro gris* ML

\*Chevreau blanc : Réf fabricant 01036002

\*Dollaro blanc : Réf fabricant 01036004

\*Dollaro gris : Réf fabricant 01036006



Masse surfacique totale / Total density		870 +- 50 g/m <sup>2</sup>	ISO 2286
Masse surfacique support / Support density		135 +- 10 g/m <sup>2</sup>	ISO 2286
Adhérence / Adhesions		> 3	ISO 2411
Epaisseur / Thickness		3.3 +- 0.3	ISO 286 10 KPa - 5 cm
Résistance par traction / Tensile strength	L T	> 20 daN > 20 daN	NFG 37 103
Allongement rupture / Elongation	L T	> 80 % > 100 %	NFG 37 103
Résistance à la déchirure amorcée / Scratching	L T	>= 3 daN >= 2 daN	NFG 37 128
Résistance aux micro-organismes / Micro organism resistance		Oui / Yes	Label Sanitized
Tenue à la lumière / Colour fastness to artif. Light		> 6	ISO 105 B02 150 h/70°/65% HR
Tenue au brouillard salin / Resistance to salt spray		Oui / Yes	NFX 41-002

### SOUS-MATELAS ANTI-CONDENSATION / Under mattress Anti-condensation

Active la circulation d'air entre la couchette et le support. Empêche la condensation et donc la formation de moisissures. Le tissage en nid d'abeille permet à la nappe de ne pas s'écraser et de retrouver sa forme originelle. Se découpe facilement sans s'effiloche.

Active air circulation between the bunk and support. Prevents condensation and thus formation of mildews. The honeycomb weaving allows the layer not to squash and to regain its original form. Easy to cut without fraying.

186410 2,10 m x 1,40 m

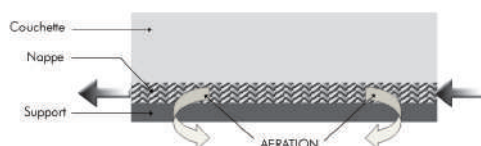
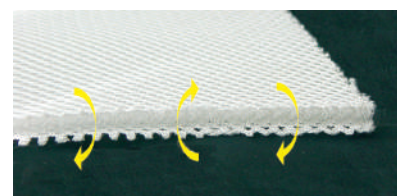

////// **ACCESSOIRES VAIGRAGE** / *Headline accessories*

↳ **COLLE NÉOPRÈNE VAIGRAGE** / *Inner hull glue for headline fabric*

⚡ Colle à double encollage pour l'aménagement intérieur des bateaux (vaigrage, moquettes, ...).

*Double sticking glue for ceiling.*

186510 400 cc



↳ **COLLE VAIGRAGE REPOSITIONNABLE PHASE AQUEUSE**  
/ *Inner-hull adhesive repositionable aqueous phase*

⚡ Colle à simple encollage, utilisée pour l'aménagement intérieur des bateaux (vaigrage, moquettes). Phase aqueuse. Il faut que la colle devienne translucide (2 h minimum à 20°C) avant d'effectuer le positionnement.

Température minimum d'utilisation : 15°C

*Simple glue sizing. Used for boat interiors (ceiling, carpets). Aqueous phase. It's necessary for the glue to become translucent (2 hours minimum at 20°C) before making a placement.*

*Minimum temperature range: 15°C*

186600 750 cc

186610 5 kg



## Tissus techniques / Sailcloth

### TISSUS À SAC / Bag fabrics

#### TISSU À SAC STANDARD NYLON ENDUIT PU 420 D / 420 D Sailbag cloth coated

TISSU nylon Enduit PU, déperlant. Grammage : 190 g/m<sup>2</sup>. Laize de 155 cm. 420 deniers. Rouleau de 100 m  
 / Coated nylon fabric could. Weight: 190 g/m<sup>2</sup>. Width: 155 cm. Roll of 100 m

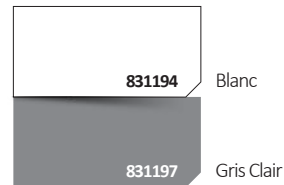
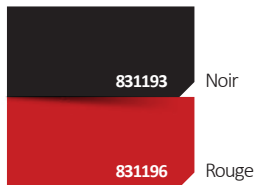
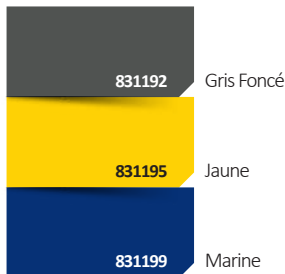

#### TISSU À SAC LOURD POLYESTER ENDUIT PU 600 D / 600 D Sailbag cloth coated

Très solide à la déchirure. Grammage : 225 g/m<sup>2</sup>. Enduit PU, déperlant. Laize : 150 cm, longueur : 50 m  
 / Very strong against tearing. Weight: 225 g/m<sup>2</sup>. Coated Polyester fabric. Width: 150 cm, length: 50 m

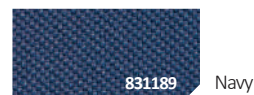

	TISSU NYLON 420D	TISSU POLYESTER 600D
<b>Poids / Weight</b>	190 g/m <sup>2</sup>	225 g/m <sup>2</sup>
<b>Largeur / Width</b>	150 cm	150 cm
<b>Enduction / Induction</b>	Enduit PU, déperlant durable	Enduit PU, déperlant durable
<b>Propriétés / Properties</b>	Traitement UV standard	Traitement UV standard
<b>Résistance Rupture / Breakage resistance</b>	Bonne tenue à la déchirure	Très solide à la déchirure
<b>Finition / Finishing</b>	Impression/ Sérigraphie : possible	Impression/ Sérigraphie : possible
<b>Applications / Applications</b>	Sacs, étuis, housses, bâches.	Sacs, étuis, housses, bâches.

#### TISSU À SAC CORDURA 1000 D / 1000 D CORDURA sailbag cloth



1100 DTX Cordura. Enduit PU. 350 gr. Excellente résistance à l'abrasion. Laize : 150 cm, longueur : 50 m  
 / 1100 DTX Cordura. Polyester coated. 350 gr. Excellent tearing resistance. Width: 150 cm, length: 50 m

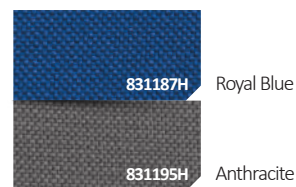
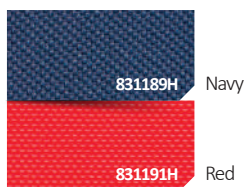
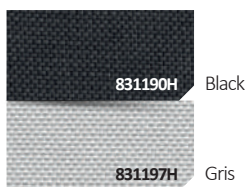

#### TISSU À SAC PE 14X14 MESH / Sailbag cloth Mesh



Réf.	Désignation	Poids (g/m <sup>2</sup> )	Largeur	Rouleau
831185	Tissu 100% polyethylene	190 gr/m <sup>2</sup>	200 cm	100 m

## ////// TISSUS À SAC / Bag fabrics

### ↳ TISSU À SAC RECYCLÉ POLYESTER 450 D / 450 D Recycled Sailbag cloth coated

/// Fabriqué 100% à base de polyester recyclé. Fabrication qui émet jusqu'à 50% en moins d'émissions de CO<sup>2</sup>.

Laize : 147 cm. Poids : 220 gr. Construction RipStop

/ Made from 100% recycled polyester. Manufactured with up to 50% less CO<sup>2</sup> emissions. Width: 147 cm. Weight: 220g. RipStop construction

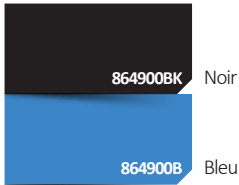

## ////// TISSUS MAILLES / Bag fabrics

### ↳ TISSUS MAILLES BLOQUÉES POLYESTER / Polyester mesh fabric blocked

/// Tissus mailles bloquées polyester. Léger et résistant. Pour drapeaux, pavillons, chaussettes à spi, ...

Grammage : 115 g. Laize de 155 cm. Rouleau de 100 m.

/ Polyester mesh blocked fabric light and resistant for flags, banners, spi socks

Weight: 115 g. Width: 155 cm. Roll of 100 m

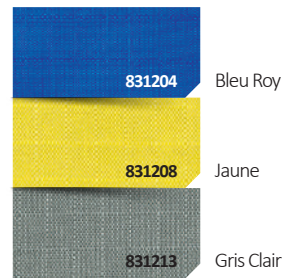

## Tissus techniques / Sailcloth

### ////// CRISTAL CLASSIC : outdoor, industrie, UV, transparence, froid et brouillard / CRISTAL CLASSIC: outdoor, industry, uv, transparency, cold and fog

Largeur : 140 cm / Width : 140 cm

Réf.	Epaisseur	Rouleau
831000	30/100	50 m
831010	40/100	50 m
831020	50/100	30 m
831005	80/100	30 m



### ////// CRISTAL LOW SHRINK / CRISTAL LOW SHRINK

Largeur : 140 cm / Width : 140 cm

Réf.	Epaisseur	Rouleau
830951	50/100	30 m
830961	65/100	30 m
830971	80/100	30 m



### ////// CRISTAL SUPER : outdoor, marine, UV++, extra transparent, résistance froid et brouillard / CRISTAL SUPER: Outdoor, marine, UV ++, extra transparent, cold resistance and fog

Largeur : 140 cm / Width : 140 cm

Réf.	Epaisseur	Rouleau
830950	50/100	30 m
830980	80/100	30 m
830991	100/100	30 m

#### DISPONIBLE EN " LOW SHRINK "

50/100 et 75/100.

Cette qualité de film transparent a été traitée spécialement pour moins de rétrécissement. Très approprié pour des applications spéciales.  
/ 50/100 and 75/100.

*This quality of transparent film has been treated specially making it less shrinking. Very suitable for special applications.*





////// CRISTAL HAUT DE GAMME / PREMIUM CRYSTAL

↳ Cristal O'SEA® / O'SEA® Crystal

/// Application marine, automobile, brise vue... Les feuilles O'SEA® polies à la presse sont résistantes à la rayure, aux UV, crèmes solaires et spray contre les insectes, sont faciles à nettoyer et possèdent une longue durée de vie. À manipuler avec précaution. Fabrication aux États-Unis.

*/ Marine, automotive, privacy screen application... O'Sea® press-polished sheets are resistant to scratches, UV rays, sun creams and spray against insects, are easy to clean and have a long lifespan. Handle with care. Manufactured in the United States.*

Réf.	Désignation
K227	Feuille O'sea® 280 x 137 cm - 0,75 mm
K228	Feuille O'sea® 280 x 137 cm - 1,02 mm



↳ Cristal Regalite® / Regalite® Crystal

/// Application marine, automobile, brise vue... Les feuilles REGALITE® polies à la presse sont résistantes à la rayure, aux UV, crèmes solaires et spray contre les insectes, sont faciles à nettoyer et possèdent une longue durée de vie. Les feuilles de cristal REGALITE® sont soudables par haute fréquence. À manipuler avec précaution. Fabrication aux États-Unis.

*/ Marine, automotive, privacy screen application... Press-polished REGALITE® sheets are scratch, UV, sunscreen and insect spray resistant, easy to clean and long lasting. REGALITE® crystal sheets are weldable by high frequency. Handle with care. Manufactured in the United States.*

Réf.	Désignation
K220	Feuille Regalite® 280 x 137 cm - 0,5 mm
K222	Feuille Regalite® 280 x 137 cm - 0,75 mm
K225	Feuille Regalite® 280 x 137 cm - 1,02 mm

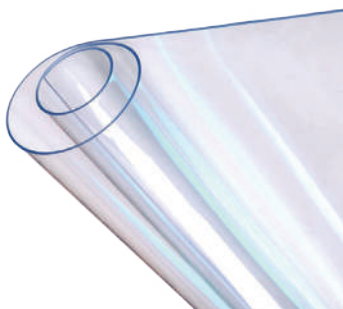

## Sacs à voiles / Sail bags

### //// Sac à voile standard / Standard sail bag

/// Forme cylindrique. Sangle poignée sur fond de sac. Fermeture par cordon. Tissu sac polyester 600D  
 / Cylindrical shape. Handle strap on bottom of bag. Drawstring closure. 600D polyester bag fabric

Réf.	Désignation
890208B	Sac Voile Basique 120 x 80 cm - Bleu
890208GF	Sac Voile Basique 120 x 80 cm - Gris Foncé
890208N	Sac Voile Basique 120 x 80 cm - Noir
890208NV	Sac Voile Basique 120 x 80 cm - Bleu Marine
890209B	Sac Voile Basique 140 x 90 cm - Bleu
890209GF	Sac Voile Basique 140 x 90 cm - Gris Foncé
890209N	Sac Voile Basique 140 x 90 cm - Noir
890209NV	Sac Voile Basique 140 x 90 cm - Bleu Marine
890210B	Sac Voile Basique 160 x 110 cm - Bleu
890210GF	Sac Voile Basique 160 x 110 cm - Gris Foncé
890210N	Sac Voile Basique 160 x 110 cm - Noir
890210NV	Sac Voile Basique 160 x 110 cm - Bleu Marine
890213B	Sac Voile Basique 180 x 130 cm - Bleu
890213GF	Sac Voile Basique 180 x 130 cm - Gris Foncé
890213N	Sac Voile Basique 180 x 130 cm - Noir
890213NV	Sac Voile Basique 180 x 130 cm - Bleu Marine



### //// Sac à spi / Spi bag

/// Forme cylindrique. Grille fond de sac avec poignée. 2 Mousquetons pour attache. Fermeture par cordon. Tissu sac polyester 600D  
 / Cylindrical shape. Bag bottom grid with handle. 2 carabiners for attachment. Cord closure. 600D polyester bag fabric

Réf.	Désignation
890306B	Sac à Spi 70 x 65 cm - Bleu
890306GF	Sac à Spi 70 x 65 cm - Gris Foncé
890306N	Sac à Spi 70 x 65 cm - Noir
890306NV	Sac à Spi 70 x 65 cm - Bleu Marine
890308B	Sac à Spi 100 x 80 cm - Bleu
890308GF	Sac à Spi 100 x 80 cm - Gris Foncé
890308N	Sac à Spi 100 x 80 cm - Noir
890308NV	Sac à Spi 100 x 80 cm - Bleu Marine



### //// Baille à spi / Spinnaker launch bag

/// Forme parallélépipède. Renforcée par des lattes. Tissu sac polyester 600D  
 / Parallelepiped shape. Reinforced with slats. 600D polyester bag fabric

Réf.	Désignation
890404B	Baille à Spi 75 x 40 x 40 cm - Bleu
890404GF	Baille à Spi 75 x 40 x 40 cm - Gris Foncé
890404N	Baille à Spi 75 x 40 x 40 cm - Noir
890404NV	Baille à Spi 75 x 40 x 40 cm - Navy
890406B	Baille à Spi 120 x 60 x 60 cm - Bleu
890406GF	Baille à Spi 120 x 60 x 60 cm - Gris Foncé
890406N	Baille à Spi 120 x 60 x 60 cm - Noir
890406NV	Baille à Spi 120 x 60 x 60 cm - Navy



## //// Sac de pont / Tube sail bag

/// Forme rectangulaire. Grille fond de sac. 2 Fermetures zip. Tissu sac polyester 600D  
 / Rectangular shape. Bag bottom grid. 2 zippers. 600D polyester bag fabric

Réf.	Désignation
890545B	Sac de Pont 4,5 m - Bleu
890545GF	Sac de Pont 4,5 m - Gris Foncé
890545N	Sac de Pont 4,5 m - Noir
890545NV	Sac de Pont 4,5 m - Bleu Marine
890550B	Sac de Pont 5 m - Bleu
890550GF	Sac de Pont 5 m - Gris Foncé
890550N	Sac de Pont 5 m - Noir
890550NV	Sac de Pont 5 m - Bleu Marine
890555B	Sac de Pont 5,5 m - Bleu
890555GF	Sac de Pont 5,5 m - Gris Foncé
890555N	Sac de Pont 5,5 m - Noir
890555NV	Sac de Pont 5,5 m - Bleu Marine



## //// Sac cordage / Ropes bag

/// 2 Poignées sangle. Fermeture zip. Tissu sac polyester 600D  
 / 2 strap handles. Zip closure. 600D polyester bag fabric

Réf.	Désignation
890640B	Sac Cordage 40 Cote 20 x 20 cm - Bleu
890640GF	Sac Cordage 40 Cote 20 x 20 cm - Gris Foncé
890640N	Sac Cordage 40 Cote 20 x 20 cm - Noir
890640NV	Sac Cordage 40 Cote 20 x 20 cm - Bleu Marine
890660B	Sac Cordage 60 Cote 30 x 30 cm - Bleu
890660GF	Sac Cordage 60 Cote 30 x 30 cm - Gris Foncé
890660N	Sac Cordage 60 Cote 30 x 30 cm - Noir
890660NV	Sac Cordage 60 Cote 30 x 30 cm - Bleu Marine



Réf.	Désignation
890999-S1	Sérigraphie Sac 1 Couleur
890999-S2	Sérigraphie Sac 2 Couleurs



## Accessoires / Accessories

Photos et couleurs de cette rubrique non contractuelles. Côtes et schémas peuvent être modifiés sans avertissement préalable.

*/ Pictures and colors are not contractual. Coasts and patterns can be changed without notice*

# ACCESSOIRES / ACCESSORIES

## Insigna / Insignia



### ////// Tissu polyester autocollant Insigna / Polyester sticker Insignia

90 g/m<sup>2</sup>. Pour numéro, renfort ou réparation. Vendu au mètre linéaire. Laize de 144 cm. Rouleau de 45,70 m.  
/ 90 g/m<sup>2</sup>. For number, reinforcement or repair. Sold by the meter. Width: 144 cm / Roll of 45,70m

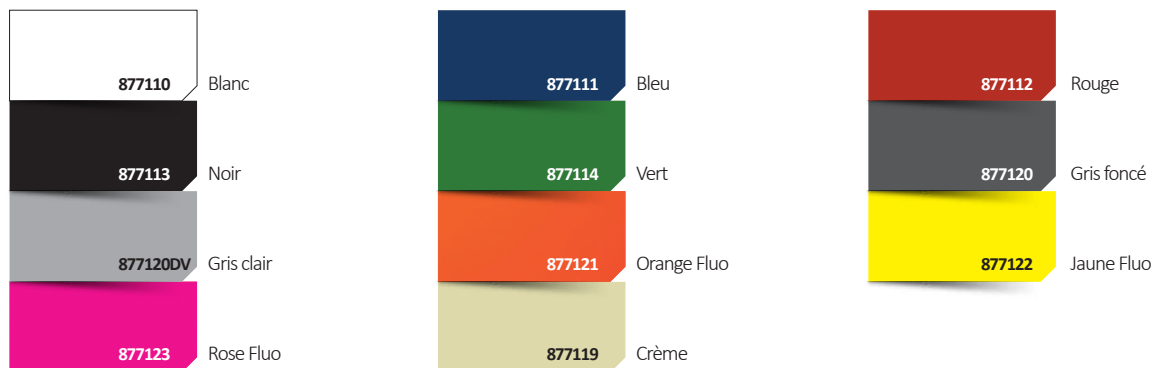

### ////// Insigna BAINBRIDGE / Insignia BAINBRIDGE



Laize 142 cm. Rouleau 45,70m / Width: 142 cm. Roll of 45,70 m

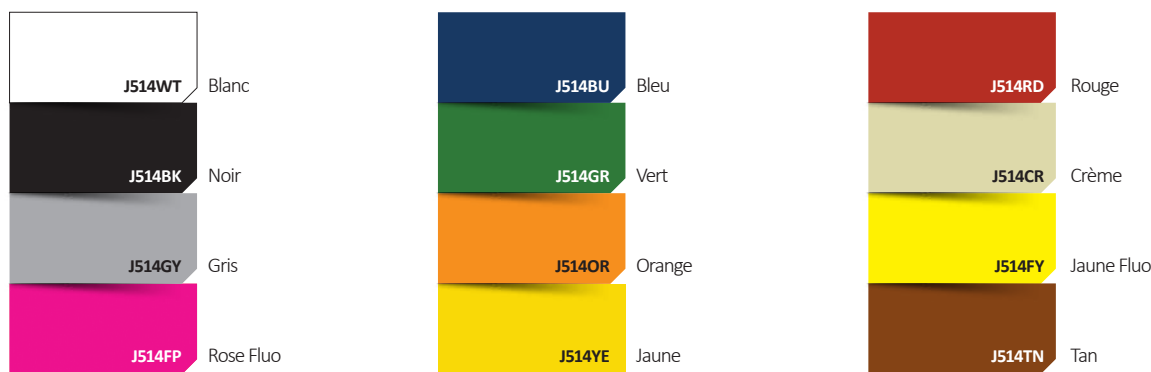

Réf.	Désignation	Réf.	Désignation
J514BK	Tissu Adhésif Insignia Noir	J514GY	Tissu Adhésif Insignia Gris
J514BU	Tissu Adhésif Insignia Bleu	J514OR	Tissu Adhésif Insignia Orange
J514CR	Tissu Adhésif Insignia Crème	J514RD	Tissu Adhésif Insignia Rouge
J514FP	Tissu Adhésif Insignia Rose Fluo	J514TN	Tissu Adhésif Insignia Tan
J514FY	Tissu Adhésif Insignia Jaune Fluo	J514WT	Tissu Adhésif Insignia Blanc
J514GR	Tissu Adhésif Insignia Vert	J514YE	Tissu Adhésif Insignia Jaune

### ////// Insigna polyester imprimable / Insignia printable polyester - E

Laize de 137 cm. Rouleau de 45,70 m / Width: 137 cm. Roll of 45,70 m

Réf.	Désignation
J515WT	Tissu Adhésif Pu Spe Serigra Blanc
J516WT	Tissu Adhésif Blanc Eduction An
J530WT	Tissu Adhésif Insignia Dacron Blanc
J530WTUV	Tissu Adhésif Insignia Dacron Blanc Uv
J550WT	Tissu Adhésif Insignia Vinyl Blanc
J614WT	Tissu Adhésif Poly Insignia Imprima



## //// Bandes de visualisation / Insignia tape

90 g. Autocollantes. Rouleau de 45 m. Disposées horizontalement sur la voile, ces bandes permettent d'apprécier le volume et la position du creux. / 90 g. Adhesives. Roll of 45 m. Placed horizontally on the sail, these bands allow to appreciate the volume and position of the sail hollow.

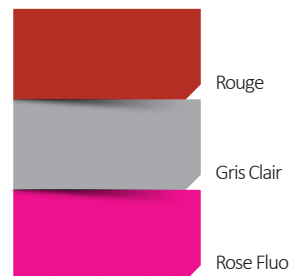
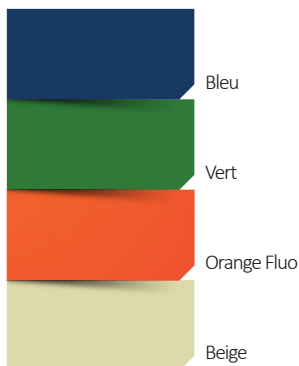
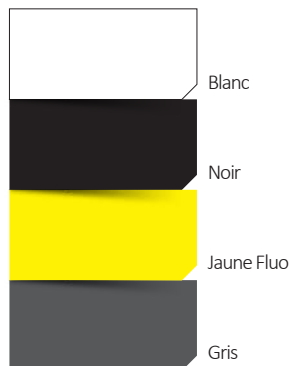

Couleur	15 mm	20 mm	25 mm	30 mm	40 mm	50 mm	60 mm	70 mm	80 mm	100 mm	120 mm	150 mm
Blanc	-	877165	877170	877175	877180	877185	877190	877200	877205	877219	877230	877239
Bleu	J015BU	877165B	877170B	877175B	877180B	877185B	877190B	877200B	877205B	877219B	877230B	877239B
Rouge	J015RD	877165R	877170R	877175R	877180R	877185R	877190R	877200R	877205R	877219R	877230R	877239R
Beige	-	877165BE	877170BE	877175BE	877180BE	877185BE	877190BE	877200BE	877205BE	877219BE	877230BE	-
Noir	J015BK	877165N	877170N	877175N	877180N	877185N	877190N	877200N	877205N	877219N	877230N	877239N
Navy	-	877165NV	877170NV	-	877180NV	877185NV	-	-	-	-	-	-
Vert	J015GR	877165V	877170V	877175V	877180V	877185V	877190V	877200V	877205V	877219V	877230V	877239V
Gris clair	-	877165GC	877170GC	877175GC	877180GC	877185GC	877190GC	877200GC	877205GC	877219GC	877230GC	877239GC
Jaune Fluo	-	877165JF	877170JF	877175JF	877180JF	877185JF	877190JF	877200JF	877205JF	877219JF	877230JF	877239JF
Orange Fluo	J015OR	877165OF	877170OF	877175OF	877180OF	877185OF	877190OF	877200OF	877205OF	877219OF	877230OF	877239OF
Rose Fluo	-	877165RF	877170RF	877175RF	877180RF	877185RF	877190RF	877200RF	877205RF	877219RF	877230RF	877239RF
Gris	J015GY	877165G	877170G	877175G	877180G	877185G	877190G	877200G	877205G	877219G	877230G	877239G

/// Nous pouvons aussi découper ce tissu dans des largeurs de votre choix / We can also cut the fabric in width of your choice.



## Insigna / Insignia

### ////// Kevlar® autocollant BAINBRIDGE / BAINBRIDGE self-adhesive kevlar® patch



Grande laize ou bandes en rouleau de 50 m / Wide width or strips in rolls of 50 m.

Réf.	Désignation
F70110Z00M	Kevlar® Autocollant Noir - Laize 137 cm
J741BK	Kevlar® Autocollant Noir - Bande 25 mm
J742BK	Kevlar® Autocollant Noir - Bande 50 mm
J743BK	Kevlar® Autocollant Noir - Bande 75 mm
J744BK	Kevlar® Autocollant Noir - Bande 100 mm



### ////// Kevlar® autocollant CHALLENGE / PSA Aramid

Kevlar® 400 denier. Laize : 137 cm. / 400 PSA Aramid. Width: 137 cm

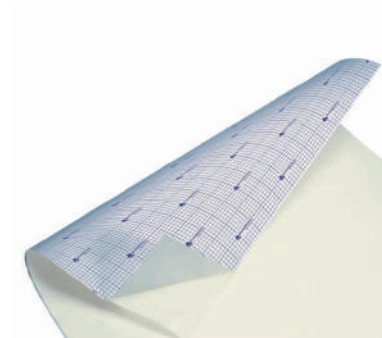

### ////// Dacron autocollant / Dacron sticker

Laize : 137 cm / Width : 137 cm

Réf.	Désignation
864137A	Dacron Autocollant Newport 7.45
864139-1A	Dacron Autocollant Newport 8.45
861142A	Dacron Autocollant Newport 9.45





## Chiffres & Lettres / Numbers & letters

### Chiffres découpés en Insigna / Insignia cutout numbers

- Les chiffres sont découpés dans un tissu insigne auto-adhésif.
- Compatible avec tous les types de toiles à voile en polyester et stratifié.

- Numbers are cut from self adhesive insignia fabric.
- Compatible with all types of polyester and laminate sailcloth.

Réf.	Taille (mm)	Couleur	Chiffres
SN100	100	BU / Bleu	0
SN150	150	RD / Rouge	1
SN230	236	WT / Blanc	2
SN250	250	BK / Noir	3
SN300	307	GR / Vert	4
SN380	394	GY / Gris	5
SN450	457	NB / Marine	6 / 9'
-	-	FP / Rose Fluo	7
-	-	OR / Orange Fluo	8



Par sachet de 10 pièces identiques / 10 identical pieces per bag.

**Exemple de commande : SN300BK7 - pour commander un 7 NOIR 300 mm**  
 / Order example: SN300BK7 - to order a 7 BLACK 300 mm

### Lettres découpés en Insigna / Insignia cutout letters

- Les lettres sont découpés dans un tissu insigne auto-adhésif.
- Compatible avec tous les types de toiles à voile en polyester et stratifié.

- Letters are cut from self adhesive insignia fabric.
- Compatible with all types of polyester and laminate sailcloth.

Réf.	Taille (mm)	Couleur	Lettres
SL230	236	BU / Bleu	A B C
SL250	250	RD / Rouge	D E F
SL305	305	WT / Blanc	G H I
SL380	380	BK / Noir	J K L
SL457	457	GR / Vert	M N O
-	-	GY / Gris	P Q R
-	-	NB / Marine	S T U
-	-	FP / Rose Fluo	V W X
-	-	OR / Orange Fluo	Y



Par sachet de 10 pièces identiques / 10 identical pieces per bag.

**Exemple de commande : SL380NBA - pour commander un A MARINE 380 mm**  
 / Ordering Example: SL380NBA - to order A MARINE 380 mm

### REPAR SPI / Nylon Repair Tape

- Réparations instantanées lorsque vous en avez le plus besoin
- Adhère instantanément au contact
- Épouse la forme de la voile
- Peut être utilisé pour la réparation d'urgence de l'équipement contre les intempéries, des coussins de siège, des housses de bateau et de la toile.
- Empêche le frottement de la voile

- Instant repairs when you need it most
- Adheres instantly on contact
- Conforms to the shape of the sail
- Can be used for emergency repair to Foul Weather Gear, Seat Cushions, Boat Covers and Canvas
- Prevents Sail Chafe

Réf.	Désignation
FWN4501	Blanc - 50 mm x 10 m
FWN4501R	Rouge - 50 mm x 10 m
FWN4501RO	Rose - 50 mm x 10 m
FWN4501V	Vert - 50 mm x 10 m
FWN4501BR	Bleu Royal - 50 mm x 10 m
FWN4501N	Noir - 50 mm x 10 m

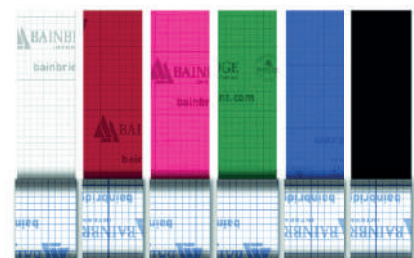

# ACCESSOIRES / ACCESSORIES

## Double-face / Double sided Tape

### Double-face Acrylique classique / Double-sided Acrylic classic

Double face voilerie, traitement anti uv (ne jaunit pas) et anti moisissures. Rouleau de 50 m.  
/ Double-sided sailmaker, anti-UV treatment (does not yellow) and anti-mould. Roll of 50 m

822150	Largeur 6 mm
822151	Largeur 9 mm
822152	Largeur 12 mm
822153	Largeur 15 mm
822154	Largeur 19 mm
822155	Largeur 25 mm
822156	Largeur 30 mm



### Double-face "Grippeur" Spécial Acrylique / Special double-sided gripper Acrylic

Double face sellerie, excellent tack. Ne pas utiliser sur tissus fins ou clairs car risque de trace. Rouleau de 50 m  
/ Double-sided upholstery, good tack. Do not use on thin or light colored fabrics because of the risk of streaking. Roll of 50 m

823000	Largeur 6 mm
823010	Largeur 9 mm
823020	Largeur 12 mm
823030	Largeur 15 mm
823040	Largeur 19 mm
823050	Largeur 25 mm

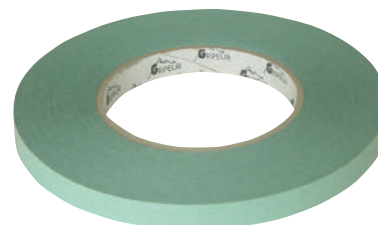

### Double-face SORO301 / Double-sided SORO301

100 % pur Acrylique. Adhère efficacement sur surface difficile tel que l'Acrylique. Collage immédiat exceptionnel. Couleur : Blanc. Rouleau de 50 m.  
/ 100 % pure Acrylic. Effectively grips on difficult surfaces such as Acrylic. Immediate bonding exceptional. Colour : White. Roll of 50 m

822299	Largeur 9 mm
822300	Largeur 12 mm
822301	Largeur 15 mm
822302	Largeur 19 mm



### Double-face TESA / Double-sided TESA

Pour le positionnement de tissus acryliques et Dacron. Très puissant. Couleur : Blanc. Rouleau de 50 m.  
/ For the positioning of acrylic fabrics and Dacron. Very powerfull. Colour: White. Roll of 50 m

822200	Largeur 9 mm
822201	Largeur 12 mm
822202	Largeur 15 mm
822203	Largeur 19 mm
822204	Largeur 25 mm
822205	Largeur 30 mm
822206	Largeur 50 mm



## //// Double-face Acrylique / Double Sided Tape - Acrylic

- Ruban adhésif double face de haute qualité pour la couture générale des voiles.
- Tack initial correct.
- Adhérence élevée à long terme.
- Support en mylar à faible étirement.
- Non jaunissant.



- High quality double sided tape for general sail seaming.
- Fair initial tack.
- High long term adhesion.
- Low stretch mylar carrier.
- Non-yellowing.

Réf.	Désignation
J451	Adhésif Double Face, Acrylique, 6 mm - Rouleau 66 m
J452	Adhésif Double Face, Acrylique, 9 mm - Rouleau 66 m
J453	Adhésif Double Face, Acrylique, 12 mm - Rouleau 66 m
J455	Adhésif Double Face, Acrylique, 19 mm - Rouleau 66 m
J456	Adhésif Double Face, Acrylique, 25 mm - Rouleau 66 m
J472	Adhésif Double Face, Acrylique 9 mm - Rouleau 33 m



## //// Double-face Mylar/Kevlar® / Mylar/Kevlar® Seaming Tape

- Conçu pour les voiles film / film stratifié, le support en tissu renforce la couture et renforce les coutures
- Tack initial correct
- Adhésif à long terme
- Porte-tissu
- Non jaunissant

- Designed for film / film laminate sails, cloth carrier strengthens seam and reinforces stitching
- Fair initial tack
- High long term adhesive
- Cloth carrier
- Non yellowing

Réf.	Désignation
J080	Adhésif Double Face, Pour Mylar, 12
J082	Adhésif Double Face, Pour Mylar, 25



Adhésifs / Adhesives

## //// Transfert 3M 9485 / 3M 9485 Transfer



Transfert acrylique haute performance. Destiné au collage définitif des tissus filmés. Adhésif sensible à la pression.

*/ High performance transfer tape, more elastic than conventionnal double sided tape. Not yellowing. Uses: excellent for spinnaker s and light sails.*

822126	Largeur 6 mm
822127	Largeur 9 mm
822128	Largeur 12 mm
822131	Largeur 15 mm
822129	Largeur 19 mm
822130	Largeur 25 mm

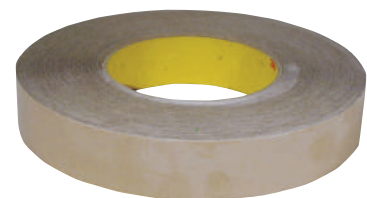

# ACCESSOIRES / ACCESSORIES

## Colles / Glue

### Colle voilerie / Sail glue

Utilisée principalement pour le collage des renforts Dacron.  
/ Mainly used for bonding Dacron reinforcement patches

822550	650 g
822552	5 litres



### Colle 3M Spray 77 / 3M 77 Spray adhesive

Permet de réaliser tout collage sur tissu polyester ou nylon.  
/ Use for gluing any kind of polyester or nylon

822500	500 ml
--------	--------



### Spray 720 / Spray 720

Permet de réaliser des collages sur mousse, PVC, tissus.  
/ Used for foam, PVC and fabrics bonding

822501	500 ml
--------	--------



### Colle Ferarri / Ferarri glue

Colle pour membrane PVC / Glue for PVC membrane

822561	1 kg
--------	------



## Mousse de rattrapage / foam

### Mousse de rattrapage de creux / Foam luff

Epaisseur : 5 mm. Laize de 1320 mm. Rouleau de 50 m, commande minimum 10 m.  
/ Thickness: 5 mm. Width: 1320 mm. Roll of 50 m, minimum order 10 m.

807714	Standard
807716	Autocollante 1 face
807719	Mousse de rattrapage Standard 10 mm

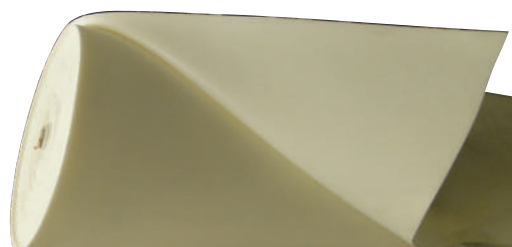

## Bandes droit-fil / Tapes

### Bandes droit-fil polyester haute tenacité / Polyester sailcloth tape

Réalisées par découpe à chaud d'un tissu polyester. Nous pouvons réaliser ces bandes droit-fil dans la largeur et le grammage que vous désirez. Largeur minimum : 25 mm / maximum : 1400 mm. Longueur : 100 m. En g/m<sup>2</sup> / Made by hot cutting a polyester fabric. We can achieve these tape in the width and weight you want. Minimum width: 25 mm / maximum 1400 mm. Length: 100 m. In g/m<sup>2</sup>



Blanc



Noir

Largeur	220g / 5smoz	260g / 6smoz	300g / 7smoz	340g / 8smoz	390g / 9smoz
25 mm	850298	851008	851028	851038	851041
40 mm	850300	851010	851030	851040	851050
50 mm	851220	851240	851260	851270	851280
60 mm	852030	852060	852100	852120	852140
70 mm	852540	852580	852620	852640	852680
80 mm	853040	853080	853120	853140	853160
100 mm	854040	854080	854120	854140	854160
120 mm	854220	854260	854300	854320	854520
150 mm	854540	854580	854620	854640	854660

Largeur	340g / 8smoz
80 mm	853120N
100 mm	854120N
120 mm	854300N

### Liserets Blanc et Couleurs / 4oz Polyester Coloured Sailcloth Tape

70g / 4 smoz. Bandes réalisées, par découpe à chaud, dans du tissu polyester. Couleurs disponibles : Blanc, Vert, Bleu, Rouge, Noir. Pour d'autres couleurs, n'hésitez pas à nous contacter. Sont présentées ici à titre indicatif les références des standards de bandes droit-fil. Longueur : 100 m. / 70g / 4 smoz. Tapes made by hot-cutting in the polyester fabric. Colours available: White, green, blue, red, black For other colors, please contact us. Are presented here as an indication of the standard reference tape. Length: 100 m.



Noir - N

Blanc



Vert - V

Rouge - R



Bleu - B

Jaune - J

Largeur	Blanc	Noir	Vert	Rouge	Bleu	Jaune
25 mm	850120	850120N	850120V	850120R	850120B	850120J
30 mm	850142	850142N	850142V	850142R	850142B	850142J
40 mm	850181	850181N	850181V	850181R	850181B	850181J
50 mm	850201	850201N	850201V	850201R	850201B	850201J
60 mm	850221	850221N	850221V	850221R	850221B	850221J
70 mm	850241	850241N	850241V	850241R	850241B	850241J
80 mm	850265	850265N	850265V	850265R	850265B	850265J
100 mm	850281	850281N	850281V	850281R	850281B	850281J



### Galons et Bandes Nylon pour spi / Braid and nylon tapes spinnaker

65g/m<sup>2</sup> - 1,53 smoz. Utilisés pour les ralingues de spinnaker. Ces bandes correspondent parfaitement aux exigences de souplesse et de légèreté des tissus à spi. Longueur : Environ 100 m / 65g/m<sup>2</sup> / 1,53 smoz. Used for ropes of spinnakers. These bands correspond perfectly to the requirements of flexibility and lightness of the spi fabrics. Length: About 100 m.



Noir - N

Blanc



Vert - V

Rouge - R



Bleu - B

Largeur	Blanc	Rouge	Vert	Noir	Bleu
25 mm	877006	877006R	877006V	877006N	877006B
30 mm	877014	877014R	877014V	877014N	877014B
40 mm	877046	877046R	877046V	877046N	877046B
50 mm	877056	877056R	877056V	877056N	877056B
60 mm	877085	877085R	877085V	877085N	877085B
70 mm	877100	877100R	877100V	877100N	877100B
80 mm	877103	877103R	877103V	877103N	877103B
100 mm	877072	877072R	877072V	877072N	877072B
120 mm	877074	877074R	877074V	877074N	877074B
150 mm	877073	X	X	X	877073B



## Bandes droit-fil / Tapes

### ////// Bandes droit-fil Nylon / Nylon Spinnaker Tape

Nylon 170g / 4smoz - Rouleau de 100 m / Nylon 170g / 4smoz - Roll of 100 m

Largeur	Vert	Rouge	Blanc
25 mm	T025GR	T025RD	T025WT
40 mm	T040GR	T040RD	T040WT
50 mm	T050GR	T050RD	T050WT
60 mm	T060GR	T060RD	T060WT
75 mm	T075GR	T075RD	T075WT
80 mm	T080GR	T080RD	T080WT



### ////// Bandes Téflon / PTFE Tape

Les fils Téflon permettent de réduire le frottement des ralingues. 342 gr / 8smoz - Rouleau de 100 m / PTFE tape reduces frictions on the luff. 342 gr / 8smoz - Roll of 100 m

Réf.	Désignation
S80080T	Bande Téflon 80 mm
S80100T	Bande Téflon 100 mm
S80125T	Bande Téflon 125 mm



### ////// Bandes Dyneema® / Dyneema® Slit Tape

Les fils de Dyneema® permettent de réduire le frottement des ralingues. Le Dyneema® renforce également la résistance, idéal sur les guindants de grand voile, Cunningham, gousset de lattes & têtes.

*The Dyneema® threads reduce the friction of the ropes. Dyneema® also adds strength, ideal on mainsail luffs, Cunningham, batten pocket & headboards.*

Réf.	Désignation	Longueur
S80125sp	Bande Dyneema 125 mm/8,11oz	RI 100 m
S80125sp20	Bande Dyneema 125 mm/8,11oz	RI 20 m



## Ralingues / Luff Tape

**Attention ! Le diamètre indiqué est un diamètre fini / Attention! The diameter shown is a finished diameter**

### //// Ralingue "Eco" soudée simple cordon / Eco single rope welded luff tape

Réalisée à partir d'un tissu polyester 1200 DTEX haute tenacité. Application idéale pour ralingue génois sur enrouleur. Rouleau de 100 m.  
/ Made from a polyester high tenacity DTEX1200. Ideal application for luff furling genoa. Roll of 100 m

876700	Ralingue Ø 4 (env. 3.8 mm fini)
876701	Ralingue Ø 5 (env. 4.8 mm fini)
876702	Ralingue Ø 6 (env. 5.7 mm fini)
876704	Ralingue Ø 7 (env. 6.8 mm fini)
876699	Ralingue Ø 9 (env. 8.8 mm fini)
876706	Ralingue Ø 8 (env. 7.8 mm fini)
876707	Ralingue Ø 10 (env. 9.8 mm fini)



/// \* Commande Noir sur demande avec minimum / Black command on request with minimum

### //// Ralingue "Eco" double cordon / Eco double rope luff tape

876708	Cordon Ø 5 fini
--------	-----------------

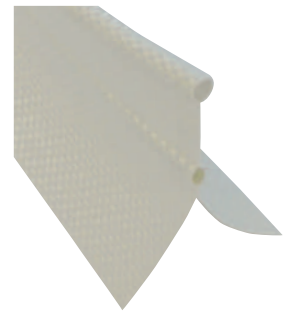

### //// Ralingue soudée double / Double rope welded luff tape

Ralingue 2 cordons / 2 rope cords

876709	Ralingue Ø 4.1 mm fini
876714	Ralingue Ø 4.6 mm fini
876717	Ralingue Ø 5.1 mm fini
876712	Ralingue Ø 5.6 mm fini



## Ralingues / Luff Tape

### Ralingue assemblée cousue / Sewn Luff tape

Les montages standards sont exécutés sur des bandes droit-fil de 100 mm et 120 mm dans un tissu de 7smoz à 8smoz. Haute tenacité.  
Rouleau de 100 m / Standard fixtures are run on straight-line bands of 100 mm and 120 mm in fabric from 7smoz to 8smoz. High tenacity. Roll of 100 m

#### Ralingue assemblée 1 cordon cousue / Luff tape - A cord sewn

Ralingue montée cousue / double couture. Jonc PVC ou cordage extra-dur. Bande de 100 mm.  
/ Climbing rope sewn / double stitching. PVC rod or rope extra hard. Strip 100 mm.

Réf.	Désignation
875510	Cordon Ø 3 jonc
875520	Cordon Ø 4 jonc
875530	Cordon Ø 4.5 jonc
875540	Cordon Ø 5 jonc
875580	Cordon Ø 6 jonc
875600	Cordon Ø 7 jonc
875660	Cordon Ø 8 jonc

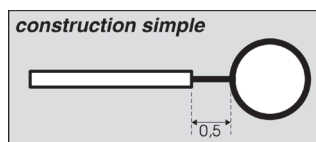

#### Ralingue double cousue "Premium" / "Premium" double rope luff tape sewn

Cordage extra dur, tressé serré haute tenacité. Tissu premier choix de 6,5smoz à 8 smoz. Code couleur pour identification facile du diamètre  
/ Extremely hard rope, tightly woven with high tenacity. First choice fabric from 6,5smoz to 8 smoz. Color code for easy identification of diameter

Réf.	Désignation	gr/m <sup>2</sup>	Code Ø	Ø finie	Cordon	Cndt.
875710	Ralingue Double Cousue	290 gr	blanc	5.50 mm	Ø5	92 ml
875715	Ralingue Double Cousue	290 gr	marron	6.50 mm	Ø5.8	92 ml
875716	Ralingue Double Cousue	290 gr	bleu	7.30 mm	Ø6.3	92 ml
875720	Ralingue Double Cousue	340 gr*	vert	8.75 mm	Ø7.1	92 ml

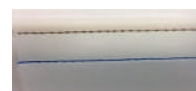

/// \*Les bandes en 340 gr sont identifiées par une couture bleu devant le guide double  
/ \* Tapes in 340 gr are identified by a blue stitch in front of the double guide

Commande x 92 ml minimum (1 boîte). Avant toutes commandes vérifier la compatibilité avec le diamètre de gorge  
/ Minimum order: x 92 ml (1 box). Before any orders check compatibility with luff size

### Jonc PVC pour ralingue / PVC band for luff tape

Réf.	Désignation	Cndt.
807890	Jonc Ralingue JC 3 ml	100 m
807900	Jonc Ralingue JC 4 ml	100 m
807910	Jonc Ralingue JC 4.5 ml	100 m
807920	Jonc Ralingue JC 5 ml	100 m
807930	Jonc Ralingue JC 5.5 ml	100 m
807940	Jonc Ralingue JC 6 ml	100 m
807945	Jonc Ralingue JC 6.5 ml	100 m
807950	Jonc Ralingue JC 7 ml	100 m
807951	Jonc Ralingue JC 7.5 ml	100 m
807960	Jonc Ralingue JC 8 ml	100 m
807965	Jonc Ralingue JC 9 ml	100 m
807980	Jonc Ralingue JC10 ml	100 m





## //// Ralingue BAINBRIDGE / Rope sewn assembly

/// Fil de couleur pour une reconnaissance rapide. Cordage extra raide de qualité. Tailles précises. Conditionnement en carton pour facilité d'usage / Colored thread for quick recognition. Quality extra stiff rope. Precise sizes. Cardboard packaging for ease of use.

Couleur	Basé sur la taille finie
ROUGE / RED	5 mm
VERT / GREEN	6 mm
BLEU / BLUE	7 mm

### ↳ Bande de ralingue Simple / Super Luff Tape - Single

Fabriquée avec bande droit fil 7smoz/300 gr x 100 mm, cousue comme précisé sur le dessin.  
/ Manufactured with 7smoz/300 gr x 100 mm straight grain tape, sewn as indicated.

Réf.	Désignation
L401	Super Luff Simple Cordage - 5 mm
L402	Super Luff Simple Cordage - 6 mm
L403	Super Luff Simple Cordage - 7 mm

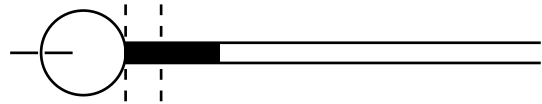

### ↳ Bande de ralingue Double / Super Luff Tape - Double

Fabriquée avec bande droit fil 7smoz/300 gr x 125 mm, cousue comme précisé sur le dessin.  
/ Manufactured with 7smoz/300 gr x 125 mm straight grain tape, sewn as indicated.

Réf.	Désignation
L441	Super Luff Double Cordage - 5 mm
L442	Super Luff Double Cordage - 6 mm
L443	Super Luff Double Cordage - 7 mm

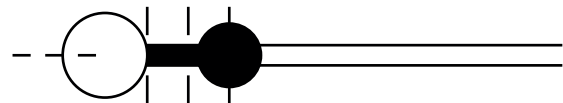

## Sangles / Webbing



### ////// Sangle polyester résistante épaisse / Heavy resistant polyester webbing

Très résistante. Pour renfort tétière, point d'écoute, point d'amure. Epaisseur 1.8 mm.  
Vendue par rouleau de 100 m.  
*/ Very strong. Headboard for reinforcement, clew, tack. Thickness: 1.8 mm. Sold by roll of 100 m*

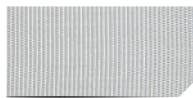

Ecru

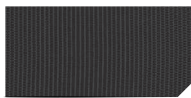

Noir

Réf.	Largeur	Couleur	Résistance	Réf.	Largeur	Couleur	Résistance
884210	20 mm	Ecru	1200 kg	884200	20 mm	Noir	1000 kg
884215	25 mm	Ecru	1400 kg	884225	25 mm	Noir	1400 kg
884230	30 mm	Ecru	1800 kg	884220	30 mm	Noir	1800 kg
884235	35 mm	Ecru	2000 kg	884240	40 mm	Noir	2400 kg
884250	40 mm	Ecru	2400 kg	884260	50 mm	Noir	3200 kg
884270	50 mm	Ecru	3000 kg	884272	80 mm	Noir	5000 kg
884271	80 mm	Ecru	4700 kg				

### ////// Sangle polyester épaisse " plus " / Heavy "plus" polyester webbing

Résistance ++. Epaisseur 2,5 mm. Vendue par rouleau de 100 m.  
*/ Cream colour with a black edging. Thickness: 2 mm. Sold by roll of 100 m*

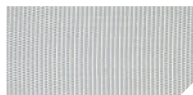

Ecru

Réf.	Largeur	Couleur	Résistance
8842355	35 mm	Ecru	2300 kg

### ////// Sangle polyester lourde / Heavy polyester webbing

Couleur écru avec liseret noir. Epaisseur 2 mm. Vendue par rouleau de 100 m.  
*/ Cream colour with a black edging. Thickness: 2 mm. Sold by roll of 100 m*



Ecru/Noir

Réf.	Largeur	Couleur	Résistance
884275	50 mm	Ecru/Noir	5000 kg

### ////// Sangle polyester Pes légère / Pes lightweight polyester webbing

Epaisseur 1.2 mm. Vendue par rouleau de 100 m.  
*/ Thickness 1.2 mm. Sold by roll of 100 m*

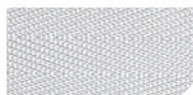

Ecru



Noir

Réf.	Largeur	Couleur	Résistance	Réf.	Largeur	Couleur	Résistance
884189	10 mm	Ecru	300 kg	884189N	10 mm	Noir	300 kg
884190	15 mm	Ecru	450 kg	884190N	15 mm	Noir	450 kg
884191	20 mm	Ecru	600 kg	884191N	20 mm	Noir	600 kg
884192	25 mm	Ecru	800 kg	884192N	25 mm	Noir	800 kg
884194	30 mm	Ecru	900 kg	884194N	30 mm	Noir	900 kg
884196	40 mm	Ecru	1200 kg	884196N	40 mm	Noir	1200 kg
884197	50 mm	Ecru	1350 kg	884197N	50 mm	Noir	1350 kg

### //// Sangle Polyester Tubulaire / Tubular polyester webbing

Vendue par rouleau de 50 m. / Sold by roll of 50 m

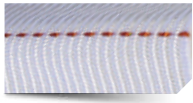

Blanc

Réf.	Largeur	Couleur	Résistance
884301	18 mm	Blanc	800 kg
884302	27 mm	Blanc	1800 kg

### //// Sangle de bordage acrylique / Acrylic strap curling

Sangle utilisée pour galonner les tauds bimini Dralon. Longueur : 150 m. Largeur : 23 mm  
/ Strap used to braid the bimini awning Dralon. Length: 150 m. Laize: 23 mm



#### COULEUR REGULAR

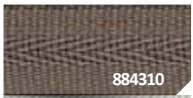

884310 Taupe 5548



884312 Natural 5020

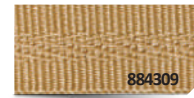

884309 Dune 5026

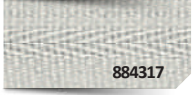

884317 Stone P011



884313 Linen 5050

#### COULEUR PREMIUM

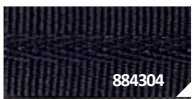

884304 Captain Navy 5057

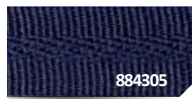

884305 Marine Blue 5031



884307 Jet Black 5032



884308 Charcoal Grey 5049

### //// Sangle Spectra® / Spectra® webbing

Sangle DYNEEMA SK 75. Epaisseur 1,1 mm / DYNEEMA SK 75 webbing. Thickness 1.1 mm.



Blanc

Réf.	Désignation	Largeur	Style	Résistance	Cndt.
884280	Sangle	20 mm	DYNEEMA ML	1370 kg	50 m
884281	Sangle	25 mm	DYNEEMA ML	1760 kg	50 m
884282	Sangle	30 mm	DYNEEMA ML	2150 kg	50 m
884284	Sangle	40 mm	DYNEEMA ML	2600 kg	50 m
884286	Sangle	50 mm	DYNEEMA ML	2900 kg	50 m

### //// Sangle de bordage polyester / Polyester strap curling

Sangle très légère pour ourlets / Lightweight belt for hem.

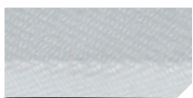

Blanc



Noir

Réf.	Largeur	Couleur	Longueur	Réf.	Largeur	Couleur	Longueur
884303	20 mm	Blanc	100 m	884303N	20 mm	Noir	100 m
884316	40 mm	Blanc	100 m	884316N	40 mm	Noir	100 m

## Sangles / Webbing



### Sangle polyester / Polyester webbing

- Sangle en polyester disponible en différents poids et largeurs
- Convient aux applications à charge moyenne/élevée
- Vendu en bobines complètes uniquement

- Polyester Webbing available in various weights & widths
- Suitable for medium/high load application
- Sold in full reels only



Blanc

Réf.	Largeur (mm)	Résistance (Kg)	Qualité	Rouleau (m)
E110	12	300	Standard	50
E111	19	500	Standard	50
E112	25	600	Standard	50
E109	12	400	Lourde	25
E127	20	500	Lourde	25
E113	25	750	Lourde	25
E114	30	850	Lourde	25
E115	40	1000	Lourde	25
E116	50	1200	Lourde	25
E108	63	1400	Lourde	25
E118	25	1500	Très résistante	25
E119	30	1800	Très résistante	25
E120	40	2400	Très résistante	25
E121	51	3100	Très résistante	25
E129	45	2800	Très résistante	25

### Sangle polyester tubulaire / Polyester Webbing - Tubular

Deux finitions : Standard ou Raide. Fabrication UK / Two finishes: Standard or Stiff. UK manufacturing

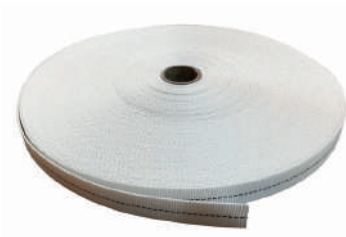

Réf.	Largeur (mm)	Résistance (Kg)	Qualité	Rouleau (m)
E124	25	1700	Standard	50
E124H	25	1700	Raide	50

### Sangle Dyneema® / Dyneema® Webbing

- Plus légère qu'une sangle Kevlar®, n'absorbe pas l'eau
- Excellente tenue aux UV & souplesse
- Dyneema® est une fibre très résistante et à faible allongement

- Lighter than Kevlar® and does not absorb water
- Excellent UV resistance and flex characteristics
- Dyneema® is a very strong and low stretch fibre

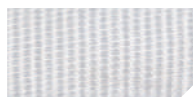

Blanc



Noir

Réf.	Largeur (mm)	Résistance (Kg)	Couleur	Rouleau (m)
E135SP	25	2800	Blanc	25
E135SPBK	25	2800	Noir	25
E139SP	45	3100	Blanc	25
E139SPBK	45	3100	Noir	25

## //// Sangle polyester renforcée / Toe Strap, Jackstay & Seatbelt Webbing

- Sangle en polyester robuste
- Recommandé pour les sangles de randonnée, les poignées de sac, le nez pour cerfs-volants, renforts, attaches, trampolines, etc.
- Excellente résistance aux UV

- Rugged polyester webbing
- Recommended for hiking straps, bag handles, nose piece for kites, reinforcement, tie down, trampolines, etc.
- Excellent UV resistance



Blanc



Noir

Réf.	Largeur (mm)	Résistance (Kg)	Couleur	Rouleau (m)
E115BK	38	1134	Noir	137,1
E121BK	50	1134	Noir	91,4
E150	25	3000	Blanc	50

## //// Sangle Polypropylène / Polypropylene Webbing

- Une conception renforcée qui en fait une sangle résistante à l'effilochage
- Traitement thermique pour de plus belles couleurs et qui améliore leur tenue aux UV
- Application pour faibles charges

- System 3 binder thread webbing process - resists fraying
- Heat treated for better colour fastness and improved UV properties
- Suitable for low load application

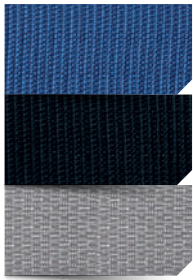

Bleu

Noir

Gris



Bleu Marine

Jaune

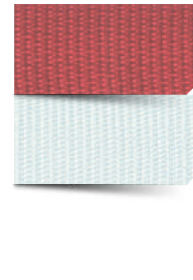

Rouge

Blanc

Réf.	Largeur	Couleur	Rouleau (m)
EP225BK	20	Black	50 m
EP225BU	20	Blue	50 m
EP225GY	20	Grey	50 m
EP225NB	20	Navy	50 m
EP225WT	20	White	50 m
EP225YE	20	Yellow	50 m
EP226BK	25	Black	50 m
EP226BU	25	Blue	50 m
EP226GY	25	Grey	50 m
EP226NB	25	Navy	50 m
EP226RD	25	Red	50 m
EP226WT	25	White	50 m

Réf.	Largeur	Couleur	Rouleau (m)
EP227BK	40	Black	50 m
EP227BU	40	Blue	50 m
EP227GY	40	Grey	50 m
EP227NB	40	Navy	50 m
EP227RD	40	Red	50 m
EP227WT	40	White	50 m
EP228BK	50	Black	50 m
EP228NB	50	Navy	50 m
EP228WT	50	White	50 m

### //// Fils Heminway & Bartlett Dabond / Heminway & Bartlett Dabond thread

Bobine de 450 gr. Fil résistant à l'abrasion, aux UV, à l'eau salée, résistant aux moisissures. Fil enduit, résistant à la chaleur de l'aiguille. Fil continu sans nœuds ni cassure.

*/ Nominal 450g / 1lb spools. Resistance to abrasion and salt water, stability in sunlight and resistance to mildew. Bonding and resistance to needle heat. Continuous thread with no knots or breaks.*

Réf.	Taille Dabond	Couleur	Réf.	Taille Dabond	Couleur
ET030WT	V30	Blanc	ET092TN	V92	Tan
ET046BK	V46	Noir	ET092WT	V92	Blanc
ET046BU	V46	Bleu	ET138BK	V138	Noir
ET046WT	V46	Blanc	ET138BU	V138	Bleu
ET069BU	V69	Bleu	ET138GY	V138	Gris
ET069GY	V69	Gris	ET138TN	V138	Tan
ET069TN	V69	Tan	ET138WT	V138	Blanc
ET069WT	V69	Blanc	ET207BK	V207	Noir
ET092BK	V92	Noir	ET207WT	V207	Blanc
ET092BU	V92	Bleu	ET346WT	V346	Blanc
ET092GY	V92	Gris			



### //// Fils Heminway & Bartlett Dabond Anti-Wick / Heminway & Bartlett Anti-Wick NANO Bonded Thread

Bobine de 450 gr. Le traitement Anti-Wick permet de renforcer la couture tout en empêchant l'eau de passer au travers des coutures.

*/ Nominal 450g / 1lb spools. Anti-Wick combines superior sewability with a permanent additive that blocks water migration through seams.*

Réf.	Taille Dabond	Couleur
EA069WT	V69	Blanc
EA092BK	V92	Noir
EA092BU	V92	Bleu
EA092GY	V92	Gris
EA092WT	V92	Blanc
EA138BK	V138	Noir
EA138WT	V138	Blanc



### //// Fil à surlier / Hand Sewing Thread & Wax

Fil à coudre main & Cire Voilier. Fourni sur bobines uniquement. Fil ciré blanc idéal pour les kits de réparation. C040 cire d'abeille naturelle. C041 composition cire d'abeille / Hand sewing thread & Sailmaker wax. Supplied on spools only. White waxed thread ideal for repair kits. C040 natural bees wax. C041 composition bees wax.

Réf.	Désignation
C041	Bloc de Cire Wax, 454 gr
EW351	Fil à surlier - 1,5 mm - Bobine 457 m
EW352	Fil à surlier - 2,0 mm - Bobine 457 m
EW352BK	Fil à surlier - 2,0 mm Noir - Bobine 457 m
EW500	Bobines de Fil Pré-ciré, Dabond V6M - Bobine 24 m / Par Boite de 12 Bobines



EW351 / EW352



EW352BK



C041



EW500

### //// Fil poisse pour finition / Waxed thread to finish

808980	Fil Poisse 2 mm, 0,5 kg / bobine
809010	Fil Poisse 1,5 mm, 0,5 kg / bobine
809030	Fil Poisse 1,5 mm, 50 g / bobine
808980N	Fil Poisse Noir Fp 2 mm, 0,5 kg
809010n	Fil Poisse Noir Fp 1,5 mm, 0,5 kg



## //// Fil machine tissé "San-Esu" Haute qualité / Woven wire rod "San-Esu" High quality

Réalisé par tissage de fil polyester, le fil "San-Esu" est un PLUS en matière de résistance à la traction, à l'abrasion et à l'allongement.  
 Résistance accrue aux UV / Made by weaving polyester yarn, thread "San-Esu" is more in tensile strength, abrasion and elongation. Increased resistance to UV.



Blanc Bleu Gris



Taille	S30	S46	S69	S92	S138	S207
Blanc	809178	809179	809180	809181	809182	809183
Bleu	/	/	809188	809186	809187	/
Gris	/	/	809189	809184	809185	/
Longueur	4200 m	3800 m	2300 m	1750 m	1100 m	800 m

/// Conditionnement par boîtes de 6 cones / Boxes of 6 cones packaging

## //// Fil machine "Dabond" / Thread "Dabond"

100 % polyester, haute tenacité, toroné, traitement spécial voilerie.  
 / 100 % polyester, high tenacity, stranded wire, special treatment sail



Blanc Noir Rouge Gris Navy Tan Beige

Taille	V92	V33/3	V69 40/3	V92 30/3	V138 20/3	V207 20/3
Blanc	809040	809143	809150	809160	809170	809071
Navy	/	809099	809105	809110	809115	/
Rouge	/	809098	809106	809111	809116	/
Gris	/	809097	809107	809112	809117	/
Tan	/	809096	809108	809113	809118	/
Noir	/	809095	809109	809114	809119	809072
Beige	/	/	/	809123	809122	/
Longueur	/	5000 m	3000 m	2500 m	1500 m	2000 m
Bobine	35 g	313 g	288 g	318 g	288 g	700 g

V92 Fusette d'appoint / Spool

V33/3 Pour spinnaker / For spinnaker

V69 40/3 Pour voile légère / For dinghy sailing

V92 30/3 Pour voile croiseur / For sailing cruiser

V138 20/3 Pour voile croiseur et renfort / For sailing cruiser and reinforcement

V20720/3 Pour renfort / For reinforcement

/// Aiguilles et paumelles / Needles and hinges / page 183

## Fils / Thread



### //// Fil machine "Dabond" outdoor / Outdoor "Dabond" thread

Fil polyester continu enduit et traité UV avec une gamme de coloris SUNBRELLA. Fil nouvelle génération avec une tenue des couleurs renforcée face à l'utilisation de produits chimiques et l'application sur des tissus enduits. Résistance UV améliorée. Applications : Voilerie, Equipements outdoor & sportifs, Sellerie, Couvertures de piscines, Sellerie Marine ( taud, bimini, coussins)

*/ Continuous polyester yarn coated and UV treated with a range of SUNBRELLA colours. New generation yarn with improved colour fastness to chemicals and application on coated fabrics. Improved UV resistance. Applications : Sailing, Outdoor & sports equipment, Saddlery, Swimming pool covers, Marine saddlery (awnings, bimini, cushions)*

Réf.	Désignation	Réf.	Désignation
809220-01	Fil Outdoor V92 Pacific Blue 2000 m	809230-01	Fil Outdoor V138 Pacific Blue 1500 m
809220-03	Fil Outdoor V92 Jockey Red 2000 m	809230-03	Fil Outdoor V138 Jockey Red 1500 m
809220-04	Fil Outdoor V92 Natural 2000 m	809230-04	Fil Outdoor V138 Natural 1500 m
809220-08	Fil Outdoor V92 Jet Black 2000 m	809230-08	Fil Outdoor V138 Jet Black 1500 m
809220-20	Fil Outdoor V92 Beige 2000 m	809230-20	Fil Outdoor V138 Beige 1500 m
809220-22	Fil Outdoor V92 Terra Cotta 2000 m	809230-22	Fil Outdoor V138 Terra Cotta 1500 m
809220-26	Fil Outdoor V92 Navy 2000 m	809230-26	Fil Outdoor V138 Navy 1500 m
809220-28	Fil Outdoor V92 Toast 2000 m	809230-28	Fil Outdoor V138 Toast 1500 m
809220-30	Fil Outdoor V92 Cadet Grey 2000 m	809230-30	Fil Outdoor V138 Cadet Grey 1500 m
809220-31	Fil Outdoor V92 Burgundy 2000 m	809230-31	Fil Outdoor V138 Burgundy 1500 m
809220-33	Fil Outdoor V92 Linen 2000 m	809230-33	Fil Outdoor V138 Linen 1500 m
809220-37	Fil Outdoor V92 Forest Green 2000 m	809230-37	Fil Outdoor V138 Forest Green 1500 m
809220-42	Fil Outdoor V92 Oyster 2000 m	809230-42	Fil Outdoor V138 Oyster 1500 m
809220-44	Fil Outdoor V92 Charcoal Grey 2000 m	809230-44	Fil Outdoor V138 Charcoal Grey 1500 m
809220-46	Fil Outdoor V92 Captain Navy 2000 m	809230-46	Fil Outdoor V138 Captain Navy 1500 m
809220-48	Fil Outdoor V92 Taupe 2000 m	809230-48	Fil Outdoor V138 Taupe 1500 m
809220-52	Fil Outdoor V92 Medit. Blue 2000 m	809230-52	Fil Outdoor V138 Medit. Blue 1500 m
809220-56	Fil Outdoor V92 Spruce 2000 m	809230-56	Fil Outdoor V138 Spruce 1500 m
809220-72	Fil Outdoor V92 Heather Beige 2000 m	809230-72	Fil Outdoor V138 Heather Beige 1500 m







## Cordage pour guindant, Nerf de chute, Kitesurf / Ropes, Leech Line, Kitesurf

### ////// Nerf de chute Kevlar® / Kevlar® leech line

Rouleau de 100 m. / Roll of 100 m

Réf.	Ø cordage	Charge maxi*
807705	2 mm	180 kg
807706	3 mm	350 kg
807707	4 mm	440 kg
807708	5 mm	520 kg
807709	6 mm	680 kg



### ////// Nerf de chute Spectra® / Spectra® leech line

Rouleau de 100 m. / Roll of 100 m

Réf.	Ø cordage	Charge maxi*
807720	2 mm	163 kg
807730	3 mm	244 kg
807740	4 mm	590 kg
807750	5 mm	989 kg
807760	6 mm	1500 kg



### ////// Nerf de chute polyester pré-étiré / Polyester leech line

Rouleau de 100 m. / Roll of 100 m

Réf.	Ø cordage	Charge maxi
808038	2 mm	142 kg
808039	3 mm	200 kg
808040	4 mm	320 kg
808041	5 mm	400 kg
808042	6 mm	590 kg

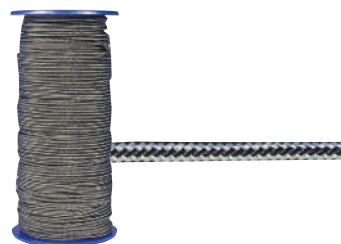

### ////// Nerf de chute polyester / Polyester drop line

Réf. Blanc	Ø cordage	Charge maxi*	Rouleau	Réf. Noir
808020	2 mm	90 kg	400 m	808-25N
808025	3 mm	180 kg	200 m	808025N
808030	4 mm	310 kg	200 m	808030N
808035	5 mm	450 kg	200 m	808035N
808037	6 mm	550 kg	200 m	808037N

808025



808025N



\*Breaking Load

### //// Cordage 16 fuseaux polyester raide / Hard braid luff line 16 braids

Anti torsion / Anti twist

807710	Ø 4
807711	Ø 4.5
807712	Ø 5
807713	Ø 8



### //// Cordage Polyester 3 torons / Polyester 3 strands rope

Réf. Blanc	Ø cordage	Charge maxi*	Rouleau	Réf. Noir
ROB-7151052	6 mm	750 kg	200 m	-
ROB-7151655	8 mm	1200 kg	200 m	-
ROB-7151054	10 mm	1950 kg	200 m	ROB-7151056
ROB-7151860	12 mm	2700 kg	150 m	ROB-7151885
ROB-7158470	14 mm	3900 kg	100 m	ROB-7151865
ROB-7158472	16 mm	4600 kg	70 m	ROB-7151704
ROB-7158582	18 mm	5700 kg	70 m	ROB-7151705
ROB-7151673	20 mm	7000 kg	100 m	ROB-7152232



/// Disponible également dans le coloris NAVY dans tous les diamètres / Also available in NAVY color in all diameters !

### //// Cordage Polypropylène 3 torons / Polypropylene 3 strands rope

Rouleau de 100 m. Léger, économique / Roll of 100 m. Light, economic.

Réf.	Ø cordage
808101	6
808102	8
808103	10
808104	12
808105	14



/// Existe aussi en noir, orange. Autres couleurs sur demande / Also available in black, orange. Other colors on request !

**À SAVOIR !**



Scannez-moi !  
/ Scan me!



\*Breaking Load

! Sur commande / On command

## Anti-torsion / Antitorsion cable

### ////// Câble anti-torsion / Antitorsion cable



Câble anti-torsion Dyneema® SK75 léger et très raide. Adapté pour enrouleur & code 0. Excellente performance à la rupture. Très faible élongation. Utilisation sur cosse cœur ou cône en épissure et/ou couture.

*/ Dyneema® SK75 antitorsion cable light and very stiff. Suitable for reel & code 0. Excellent breaking performance. Very low elongation. Use on core terminal or cone in splice and/or sewing.*

Réf.	Désignation	Rlx
661007	Anti-torsion Dynex Furl 7 mm	200 m
661009	Anti-torsion Dynex Furl 9 mm	200 m
661011	Anti-torsion Dynex Furl 11 mm	200 m
661013	Anti-torsion Dynex Furl 13 mm	200 m
661015	Anti-torsion Dynex Furl 15 mm	200 m
661017	Anti-torsion Dynex Furl 17 mm	200 m
661019	Anti-torsion Dynex Furl 19 mm	200 m

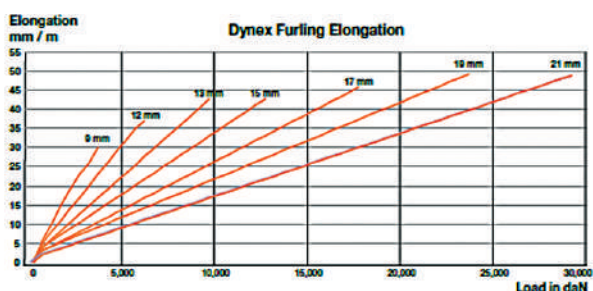

### ////// Manchons colligo anti-torsion / Antitorsion colligo sleeves

Boîtier pour fixation type "manchon" sur câble anti-torsion. Idéale pour finition avec cosse cœur.  
*/ Box for "clamp" mounting on furling cable. Ideal for thimble finishing.*



Fonctionne avec tous types de tresses. Utilisation sur câble anti-torsion, étai, code 0, gennaker. Mise en œuvre rapide et facile avec capacité d'ajustement des longueurs. Possibilité de double manchonnage si nécessaire.

*/ Works with all types of braids. Use on furling cable, frontstay, code 0, gennaker. Fast and easy installation with length adjustment capability. Possibility of double sleeving if necessary.*

Réf.	Désignation
620059	Manchon / Clamps Anti-torsion 9-11 mm
620060	Manchon / Clamps Anti-torsion 12-13 mm
620061	Manchon / Clamps Anti-torsion 14-15 mm
620064	Manchon / Clamps Anti-torsion 16-17 mm
620065	Manchon / Clamps Anti-torsion 18-19 mm



## Coulisseaux / Slides

### ////// Coulisseaux plastiques / Plastic slides

Réf.	Appellation	Larg.	Long.	H	Ep.	Cdt.
800010	GV CGV 15	15	30	18	3	x
800005	CGV HA 89	16	32	22	4	x
800020	GV CGV 19	19	35	23	4	x
800030	GV CGV 23	23	40	25	5	x

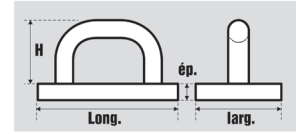

### ////// Coulisseaux lubrifiés plats / Lubricated slides flat

Réf.	Larg.	Long.	H	Ep.	Cdt.
800293	16	45	14	11	x
800294	19	45	14	12	x
800295	22	45	13	13	x

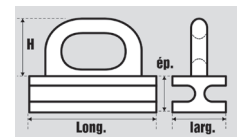

### ////// Coulisseaux inox 316L / 316L stainless steel slides

Réf.	Appellation	Larg.	Long.	H	Ep.	Cdt.
800290	CGV TI 15	15	43	21	3	x
800300	CGV TI 17	17	43	22	3	x
800310	CGV TI 19	19	43	23	3	x
800320	CGV TI 23	23	43	24	3	x
800325	CGV TI 30	30	43	24	3	x

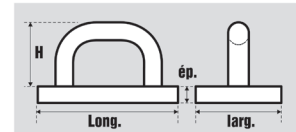

### ////// Coulisseaux lubrifiés ronds / Lubricated slides round

Réf.	∅ A	Long.	H	Cdt.
800290-1	7	44	14	x
800291	9.2	44	14	x
800292	11	44	14	x

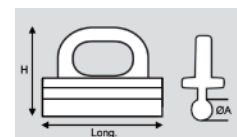

# ACCESSOIRES / ACCESSORIES

## Coulisseaux / Slides

### //// Coulisseaux lubrifiés SELDEN / Lubricated slides SELDEN

Réf.	Larg.	Long.	H	Ep.
800296	15	40	14	18
800304	19	43	14	14

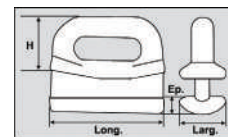

### //// Coulisseaux pour rail / Slides rail

Réf.	Appellation	Larg.	Long.	H	Ep.
800050	CGV 10	13	35	15	15
800040	CGV 11	10	25	12	11

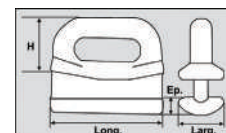

### //// Coulisseaux pour rail / Slides rail

Réf.	Appellation	Larg.	Long.	H	Ep.
800400	CGV30	17	40	23	10

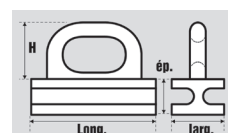

### //// Coulisseaux plastiques / Plastic slides

Réf.	Appellation	Ø A	Long.	H
802700	GV CGV 158	9	22	29
802700H	GV CGV 158	x	x	x
802800	GV CGV 358	12	22	30
802800H	GV CGV 358	x	x	x

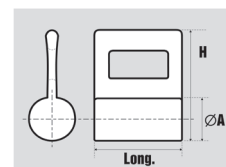

### //// Coulisseaux mixtes / Mixed slides

Coulisseaux à tige inox moulée. / Molded steel rod slides

Réf.	Appellation	Ø A	Long.	H
800540	CB5	8	50	21.5
800545	CB6	10	50	22.5
800550	CB7	12	50	23

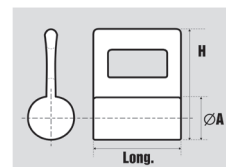

### //// Coulisseaux nickelé / Nickel slides

Réf.	Appellation	Ø A	Long.	H
800521	CB3	11	72	26



### //// Coulisseau avec boucle inox soudée / Slug Slides with Welded - Stainless Steel Bail

Anse soudée moulée pour une résistance maximale / Moulded-in welded bail gives maximum strength

Réf.	Ø	Largeur	Longueur	Cdt.
A016S	6.9	2.5	27	10
A017S	8	2.5	27	10
A019S	10	3.2	30	10
A018S	11	3.4	30	10



### //// Coulisseau interne inox / Internal slug slides - stainless steel

Acier inoxydable coulé, électropoli. Revêtement PTFE à faible friction / Cast stainless steel, electro-polished. Low friction PTFE coating

Réf.	Ø	Largeur	Longueur	Cdt.
B035	7.5	3.5	37	1
B036	8.6	3.5	37	1
B037	10.5	3.5	37	1



### //// Coulisseau interne aluminium / Internal slug slides - cast alloy

Moulé sous pression en alliage d'aluminium et revêtu de PTFE / Diecast in aluminium alloy and coated with PTFE

Réf.	Ø	Largeur	Longueur	Cdt.
B101	11	2.5	31	1
B102	11	4	73	1
B103	12	4	78	1



### //// Coulisseau moulé renforcé / Heavy duty slug slides with moulded in bail

Moulé par injection en nylon à faible frottement, avec anse captive en acier inoxydable.

A031C est conçu pour les bômes de dériveur modernes avec des ouvertures de rainure très étroites.

Également utilisé comme point d'armure flottant pour donner une fixation rapprochée de la voile au mât.

Injection moulded in low-friction nylon, with captive stainless steel bail.

A031C is designed for modern dinghy booms with very narrow groove openings.

Also used as a floating tack to give close-in attachment of sail to mast.



Réf.	Ø	Largeur	Longueur	Cdt.
A031C	8	1.7	50	10
A031	8	3	50	10
A032	9	3	50	10
A033	12	4	73	10

### //// Coulisseau renforcé inox / Heavy duty slug slides - stainless steel

Moulé sous pression en acier inoxydable, électropoli.

Revêtement PTFE à faible frottement.

Peut également être utilisé pour les glissements de tête.

Diecast in stainless steel, electro-polished.

Low friction PTFE coating.

Can also be used for head slides.



Réf.	Ø	Largeur	Longueur	Cdt.
B011	7.5	3	74	1
B012	9	3	75	1
B013	12	3	75	1

### //// Coulisseau externe inox / External slides - stainless steel

Acier inoxydable 316, glissière électropoli.

Spécialement conçu pour les systèmes de chenilles externes.

Attacher à la voile avec une sangle ou un arrimage.

Recommander la ligne de laçage EW352 pour l'arrimage à la voile.

316 stainless steel, electro polished slide

Specifically designed for external track systems

Attach to sail with webbing or lashing

Recommend EW352 lacing line for lashing to sail



Réf.	Taille du rail	Cdt.
B014SS	15	10
B015SS	22	10
B016SS	25	10

## Coulisseaux / Slides

### //// Coulisseau plastique plat / Internal flat slides - plastic

Moulé par injection à partir de nylon 66 / Injection moulded from nylon 66

Réf.	Ø	Largeur	Longueur	Cdt.
A007	15.8	6.8	30	10
A008	19	9	33	10
A009	22	11	35	10



### //// Coulisseau inox plat / Internal flat slides - stainless steel

Acier inoxydable coulé, électropoli. Revêtement PTFE à faible frottement / Cast Stainless Steel, electro-polished. Low friction PTFE coating

Réf.	Ø	Largeur	Longueur	Cdt.
B307	16	7	40	10
B308	20	7	40	10
B309	22	7	40	10



### //// Coulisseau plastique SELDEN / SELDEN mast slides - plastic

Réf.	Ø	Largeur	Longueur	Cdt.
A011	20	8.5	30	10
A012	20	8.5	40	10
A013	11	3	22	10
A014	14	4	30	10
A015	15	4	40	10



A011 / A012



A013 / A014 / A015

### //// Coulisseau inox SELDEN / SELDEN mast slides - stainless steel

Acier inoxydable coulé, électropoli. Revêtement PTFE à faible frottement / Cast Stainless Steel, electro-polished. Low friction PTFE coating

Réf.	Ø	Largeur	Longueur	Cdt.
B044	14	4	37	10



### //// Coulisseau faible friction / Allslip low friction slide

Sept profils pour s'adapter à la plupart des longerons modernes. Moulé avec précision à partir de plastique renforcé de fibre de verre avec une imprégnation de PTFE.

Le patin de compression intégré transfère les charges sur la face arrière du longeron.

A114 est conçu pour être utilisé dans les sections Selden équipées de vannes affleurantes.

Seven profiles to fit most modern spars.

Precision moulded from glass fibre reinforced plastic with a PTFE impregnation.

Integral compression pad transfers loads on to aft face of spar.

A114 is designed for use in Selden sections fitted with flush gates.

Réf.	Ø	Largeur	Longueur	Cdt.
A107	15.8	7	45	10
A108	19	9	45	10
A109	22	11	45	10
A114	15.5	4.4	45	10
A116	7.5	4	45	10
A117	8.5	4	45	10
A118	11.5	4	45	10



### //// Coulisseau plastique / Internal slug slides - plastic

Moulé par injection à partir de nylon 66 / Injection moulded from nylon 66

Réf.	Ø	Largeur	Longueur	Cdt.
A016	7.5	3	27	10
A017	9	3	27	10
A018	12	3	27	10





## Coulisseaux pour voiles Full Batten / Slides for Full Batten sails

### ////// Coulisseau intermédiaire / Slide through

800035                       $\varnothing$  10 mm



### ////// Coulisseau articulé / Articulated slide

800033                       $\varnothing$  10 mm



### ////// Coulisseaux lubrifiés Full Batten / Lubricated slide Full Batten

800490	8 mm
800491	9.5 mm
800492	12 mm
800493	16 mm
800495	22 mm
800496	Selden



Accastillage / Sailmaking hardware

## Cardan inox / Stainless steel universal joint

### ////// Cardan inox articulé / Stainless steel toggle M10

800278                      Cardan inox articulé



Sur demande PDF gamme Sailman / PDF Sailman range on demand

## Manilles / Shackles



### Manilles à vis / Screw on shackles

Livrée avec visserie. / Supplied with screws

Réf.	Modèle	Hauteur	Long.
802640	Grand	48	7
802660	Petit	44	6



### Manilles à frapper / Snap-in shackles

Réf.	Modèle	Hauteur	Long.
802600	Grand	44	7
802620	Petit à ergot	36	8



### Manille plastique à visser / Screw-on shackles - plastic

Réf.	Modèle	A (mm)	L (mm)	W (mm)
A027	Petit	28	45	10
A026	Grand	27	47	11
A028	Grand avec ergot	27	47	11



### Manille à frapper / Snap-in shackles - plastic

Réf.	Modèle	A (mm)	L (mm)	W (mm)
A022	Petit	22	39	10
A021	Grand	28	45	11
A023	Petit avec ergot	22	39	10
A024	Grand avec ergot	28	45	11



### Manille plastique noire à visser longue / Long reach screw-on shackles

Réf.	A (mm)	L (mm)	W (mm)	Cdt.
A035BK	45	61	11	1



### Manille inox à visser / Screw shackles - stainless steel

Réf.	Compatible avec	L (mm)	W (mm)
B129	A016S/A018S/B014 / B016	16	10
B130	A016S/A018S/B014 / B017	20	10
B131	A016S/A018S/B014 / B018	24	10
B110	A031/ A033/B307/ B309	34	15



### Protecteur / Protector

Réf.	Compatible avec	Cdt.
A511	B506 / B510 / B511 / B701	100
A513	B505 / B513	100
A514	B508 / B514 / B515	100



## Mousquetons / Hanks & Snaps

### ////// Mousquetons laiton à piston / Forged brass piston hanks

Réf.	Désignation	Long.	Ø étai maxi	Charge rupture
804500	MPL 40	40	7	80 kg
804510	MPL 50	50	10	130 kg
804520	MPL 60	60	12	250 kg
804530	MPL 75	75	14	360 kg

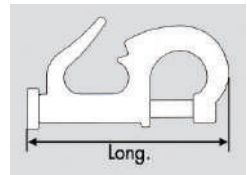

### ////// Mousquetons laiton à piston à coudre / Forged brass piston hanks sewing

Réf.	Désignation	Long.	Ø étai maxi	Charge rupture
804501	MPL 30	31	5	60
804511	MPL 40	43	7	80
804521	MPL 50	53	10	130
804531	MPL 60	63	12	250

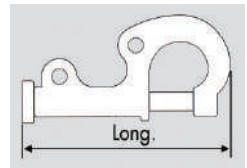

### ////// Mousquetons bronze à frapper / Bronze jib hanks

Mousqueton / Bague de foc WICHARD. / Jib hanks / Ring foc Wichard.

Réf.	Désignation	Long.	Ø A	Ø B	Fonct.	Ch. rupture
804600	MLR 50	50	7.5	6.5	100 kg	150 kg
804620	MLR 55	55	9	8	150 kg	200 kg
804640	MLR 65	65	11	10	250 kg	300 kg

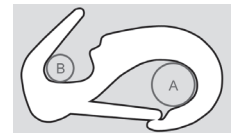

### ////// Mousquetons plastiques / Plastic sail hanks

Mousqueton en injection plastique chargé de verre. Idéal pour utilisation sur étai textile / Carabiner in plastic injection filled with glass. Ideal for use on textile forestay.

Réf.	Désignation	Ø Max	A	B	C	D	C.R
804581	Mousq, Hanks 01 Mini	10	10	6	36	63.5	340 kg
804582	Mousq, Hanks 02 Small	18	23	6.5	58	87	450 kg

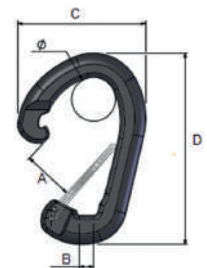

### ////// Mousqueton laiton forgé suédois à pistons / Swedish forged brass piston hanks

Les écheveaux suédois en laiton sont réputés dans le monde entier pour sa qualité, fiabilité et facilité de montage.

Forgé à partir de laiton de qualité marine et équipé de ressort en acier inoxydable.

B516 a une ouverture de mâchoire de 255 mm et dimensions internes de 25 mm x 29 mm. Il est conçu pour être utilisé sur les systèmes d'étai pour les tourmentins, pas pour les grands génois.

Swedish brass jib hanks are renowned world-wide for quality, reliability and ease of fitting

Forged from marine quality brass and fitted with stainless steel spring

B516 has a jaw opening of 255mm and internal dimensions of 25mm x 29mm. It is designed for use over forestay systems for storm jibs, not for large genoas.



Réf.	Taille	Longueur (mm)	Etai max (mm)	Cdt.
B510	0	44	8	10
B511	1	52	9	10
B512	2	65	12	10
B513	3	74	15	10
B514	4	82	17	10
B515	5	95	20	10
B516	6	107	-	10

## Mousquetons / Hanks & Snaps

### Mousquetons inox à frapper / Stainless steel jib hanks

Mousqueton / Bague de foc WICHARD / Snap hank / WICHARD Jib ring

Réf.	Désignation	Long.	Ø A	Ø B	Fonct.	Ch. rupture
805000	MIF 50	50	7.5	6.5	200 kg	250 kg
805010	MIF 55	55	9	8	300 kg	350 kg
805020	MIF 65	65	11	10	500 kg	550 kg
805030	MIF 80	80	13	11.5	700 kg	800 kg
805040	MIF 90	90	17	13	1000 kg	1050 kg

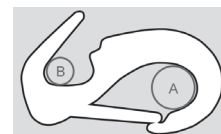

Mousqueton de foc / Piston hank

Réf.	Long.	Ø ID1	Ø ID
805150	50	7	6

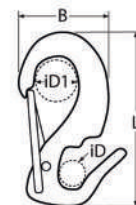

### Mousquetons inox à œil à sangler / Stainless steel tack hook

Mousqueton à ressort de sécurité WICHARD / WICHARD spring safety hank

Réf.	Désignation	Long.	Ø A	Ø B	Fonct.	Ch. rupture
805500	MIO 50	50	8	6	250 kg	300 kg
805510	MIO 75	75	12	10	600 kg	700 kg
805520	MIO 100	100	16	13	1400 kg	1500 kg

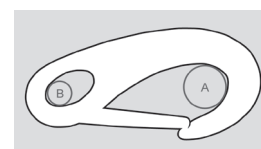

### Mousquetons plastiques type 1/4 de tour pour foc / Twist-on plastic jib hanks

Réf.	Désignation	Long.	Ø étai maxi
804550	Petit	32	6
804560	Grand	33	7.5



### Mousqueton plastique à visser / Plastic piston jib hanks

Réf.	Désignation	Long.	Ø étai maxi
804570	88A	50	5



### Mousqueton rapide en aluminium (attache jumelle) / Sister clips

805540 Petit modèle



### Mousquetons pompiers inox

Avec œil / With eye

Réf.	Ø	L	D	A	C	BL/Kg
508427	5	50	7	6	8	800 kg
508428	6	60	7,5	8	9	850 kg
508423	7	70	9,5	8	9	1200 kg
508433	8	80	10,5	8	9	1200 kg
508449	10	100	14	10	12	1750 kg

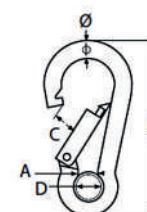

Sans œil / Without eye

Réf.	Ø	L	D1	A	C	BL/Kg
508426	5	50	10	6	8	760 kg
508429	6	60	11	8	9	900 kg
508437	7	70	13	8	9	1370 kg
508438	8	80	13	8	9	1500 kg
508440	10	100	16	10	12	1900 kg

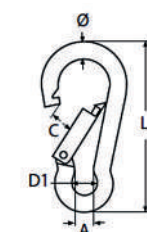

# Clamcleat / Clamcleat

## Clam suédois / Gransegel cleats

Réf.	Désignation	Modèle	Nb trou	Hauteur	Ø
810000	CS1	Petit	2	29	4
810010	CS2	Moyen	3	44	5
810020	CS3	Maxi	4	58	6



## Clamcleat

Réf.	Désignation	Type	Ø nerf
811036	CL 211	Clamcleat 211 MK2	2 à 5
811010	CL 212	Clamcleat 212 Complet	2 à 5
CL212	CL 212	Clamcleat 212 à Coudre	2 à 5
CL214W	CL 214	Clamcleat 214 à Coudre	2 à 5
811020	CL 214	Clamcleat 214 Complet	2 À 5



Réf.	Désignation	Type	Ø nerf
811000	CL 221	Clamcleat 221 Nylon Complet	1 à 5
811011	CL 223	Clamcleat 223 Nylon Complet	2 à 6
811031	CL 223	Clamcleat 223 Nylon Noir Complet	2 à 6
811030	CL 233	Clamcleat 233 Nylon Complet	2 à 6
CL233	CL 233	Clamcleat 233 Nylon à Coudre	2 à 6



Réf.	Désignation	Type	Ø nerf
811022	CL 241	Clamcleat 241 Alu Complet	3 à 6
811023	CL 241	Clamcleat 241 Alu à Coudre	3 à 6
811027	CL 241	Clamcleat 241 Anodise Complet	3 à 6
811021		Contre Plaque CL 212 et CL 241	-



## Clamcleat / Clamcleat

### Clamcleat

Réf.	Désignation	Type	Ø nerf
811024	CL 258	Clamcleat 258 Alu Ouvert Tribord Complet	3 à 6
811028	CL 258	Clamcleat 258 Anodise à Coudre	3 à 6
811029	CL 258	Clamcleat 258 Anodise Complet	3 à 6
CL259	CL 259	Clamcleat 259 à Coudre	3 à 6
811025	CL 259	Clamcleat 259 Alu Ouvert Babord Complet	3 à 6
811032	CL 259	Clamcleat 259 Anodise Complet	3 à 6



Réf.	Désignation	Type
811034	CL 267	Clamcleat 267 Alu Complet
CL267	CL 267	Clamcleat 267 à Coudre
CL268	CL 268	Clamcleat 268 à Coudre
811035	CL 269	Clamcleat 269 Nylon Complet
CL270	CL 270	Clamcleat 270
CL273	CL 273	Clamcleat 273 à Coudre
CL273AN	CL 273	Clamcleat 273 anodise
CL273PR	CL 273	Clamcleat 273 à Riveter



Autres Clamcleat sur demande.

/ Other Clamcleats on request.

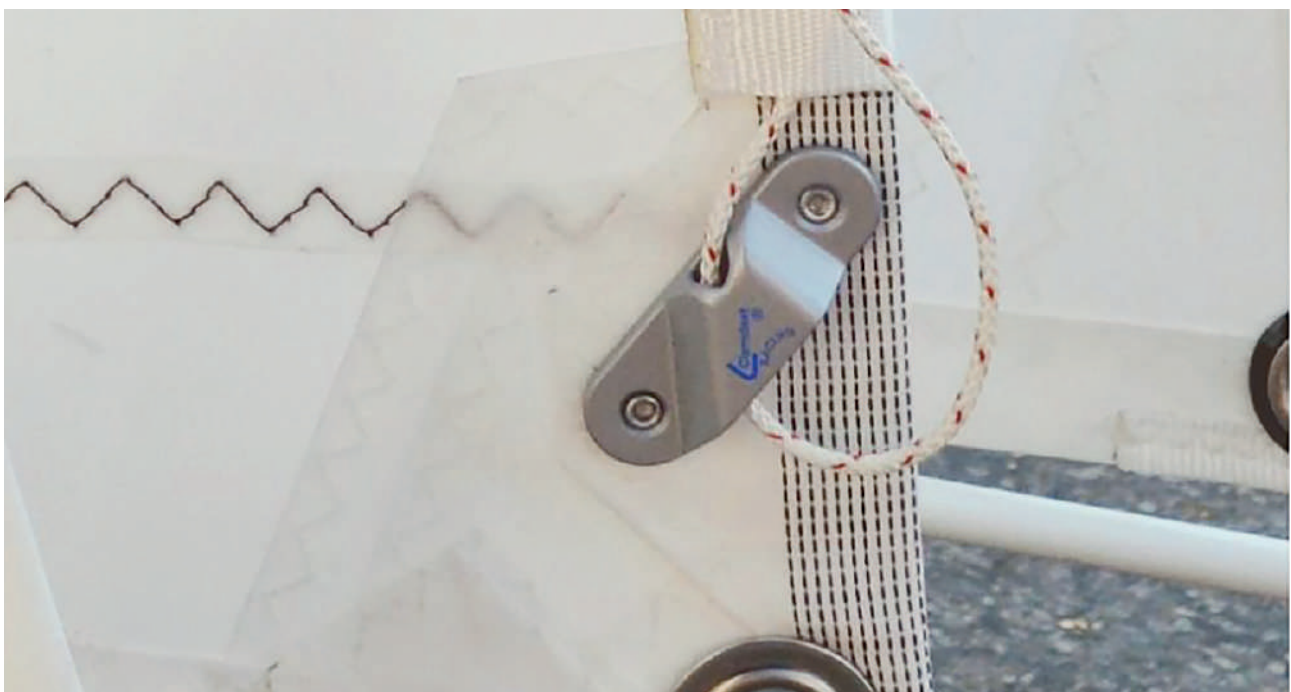

## Têtières / Headboard

### Têtière aluminium évidée / Aluminium hollow headboard

Têtière anodisée noir. Fixation par cosse standard ou rivets Ø5. Passage sangle 26 mm (33 mm réf. 804650 / 804670).

Plus légère. Plus résistante. Pose rapide.

/ Black anodized headboard. Fixing by standard lugs or rivets Ø5. Webbing slide 26 mm (33 mm ref. 804650 / 804670).

Lighter. More resistant. Quick installation.

Réf.	Désignation	A	B	Epaisseur	Couleur
802949	Têtière Alu VMG	80	115	2	Noir
802955	Têtière Alu VMG	80	115	2	Gris
802950	Têtière Alu VMG	115	140	2	Noir
802960	Têtière Alu VMG	115	140	2	Gris
802951	Têtière Alu VMG	115	140	3	Noir
802961	Têtière Alu VMG	115	140	3	Gris
803020	Têtière Alu VMG	135	160	3	Noir
803120	Têtière Alu VMG	135	160	3	Gris
803022	Têtière Alu VMG	160	190	3	Noir
803122	Têtière Alu VMG	160	190	3	Gris
803023	Têtière Alu VMG	185	220	3	Noir
803123	Têtière Alu VMG	185	220	3	Gris

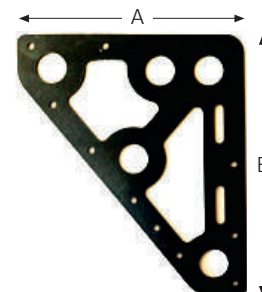

### Anodisation gris / Grey anodizing

Réf.	Désignation	A	B	Epaisseur	Couleur
HBA912GY	Têtière Alu SAILMAN	123	100	2	Gris
HBA913GY	Têtière Alu SAILMAN	123	100	3	Gris
HBA922GY	Têtière Alu SAILMAN	142	116	2	Gris
HBA923GY	Têtière Alu SAILMAN	142	116	3	Gris
HBA932GY	Têtière Alu SAILMAN	165	135	2	Gris
HBA933GY	Têtière Alu SAILMAN	165	135	3	Gris
HBA943GY	Têtière Alu SAILMAN	189	155	3	Gris
HBA944GY	Têtière Alu SAILMAN	189	155	4	Gris
HBA953GY	Têtière Alu SAILMAN	222	181	3	Gris
HBA954GY	Têtière Alu SAILMAN	222	181	4	Gris
HBA963GY	Têtière Alu SAILMAN	271	221	3	Gris
HBA964GY	Têtière Alu SAILMAN	271	221	4	Gris

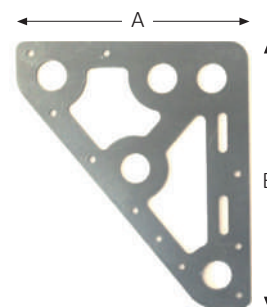

### Têtière composite VMG / Headboard composite VMG

Polyacrylate chargé de verre. Livrée complète (2 plaques)

/ Glass filled polyacrylate. Delivered complete (2 plates)

Réf.	A	B	C	Ep.	Cosse
803149	115	145	175	3	883200 / 883202

### Couleur : Gris. Livrée par plaque à l'unité.

/ Color: Grey. Delivered by plate unit.



### Têtière plastique / Plastic headboard

Livrée par plaque à l'unité. / Delivered by plate unit

Réf.	A	B	C	Ep.
803150	115	145	175	3



**Têtières / Headboard**



**Têtière plastique / Plastic headboard**

Têtières a utiliser avec cosses D037 & rivets D331 / Faceplates to be used with D037 lugs & D331 rivets

Réf.	A	B	Epaisseur
A043	75	100	3 mm
A044	100	115	3 mm
A045	150	150	3 mm
A048	145	145	3 mm
A049	115	130	3 mm
A052	115	140	3,5 mm

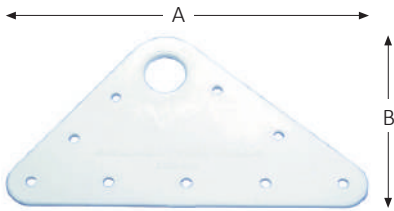

A043

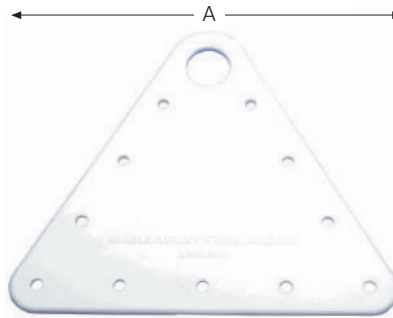

A045

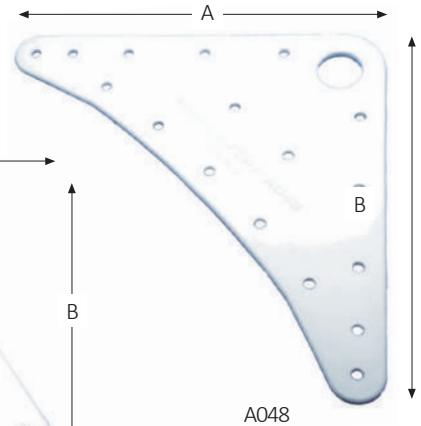

A048

Vendues par paire / Sold in pairs

**Plaque point d'écoute / Clewboard**

**Plaque point d'écoute alu anodisée grise / Aluminium anodised clew board**

Pour solent, catamaran, planche à voile, ... / For solent, catamaran, windsurfing

Réf.	Désignation	Ep.	Couleur	Taille	Nb de trou	Cndt.
803050	Plaque Pt Ecoute PM	2 mm	Grise	140 x 40	3 Trous	10
803050N	Plaque Pt Ecoute PM	2 mm	Noir	140 x 40	3 Trous	10
803052	Plaque Pt Ecoute MM	3 mm	Grise	190 x 40	4 Trous	10
803055	Plaque Pt Ecoute GM	3 mm	Grise	240 x 40	5 Trous	10

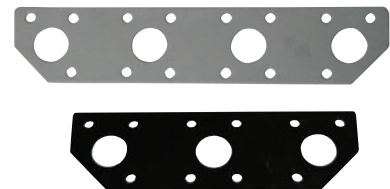

**Plaque point d'écoute alu anodisée Sailman / Sailman anodised aluminium clew board**

Réf.	Désignation	Epaisseur	Taille	Trous
CBA813GY	Plaque Point Ecoute PM	3 mm	201 x 42	5
CBA833GY	Plaque Point Ecoute MM	3 mm	306 x 71	9
CBA834GY	Plaque Point Ecoute MM	4 mm	307 x 71	9
CBA853GY	Plaque Point Ecoute GM	3 mm	396 x 79	11
CBA854GY	Plaque Point Ecoute GM	4 mm	397 x 79	11

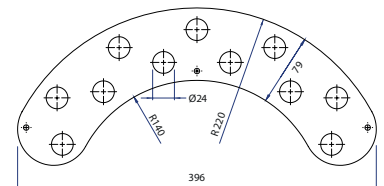
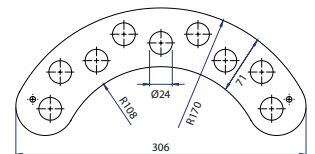
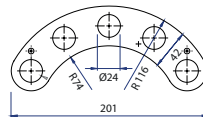



### //// Rivets de tête / Rivet headboard

Par boîte de 1000 pièces / Box of 1000 pieces

Réf.	Ø	Long.	Outil de pose	Outil de découpe
D331	3,9	9,5	C325	C102
D332	3,2	9,5	C324	C101
D334	3,9	12,7	C325	C102
D335	4,8	9,5	C326	C103
D336	4,2	12,5	C326	C103
D337	4,8	12,7	C326	C103
D339	4,8	15,9	C326	C103



### //// Outil de pose / Setting tool

803528 Pour rivet alu



### //// Cosses inox / Steel pods

Réf.	Matériau	Ø int.	Ø ext.	Haut.	Ep.	Réf. Matrice
883200	Inox 316L	14	16	16	1,5	881850
883202	Inox 316L	14	16	20	1,5	881850
883240	Inox 316L	19	23	22	1,5	881880



### //// Cosses inox Sailman / Sailman steel pods

Pour utilisation avec la gamme de têtes et plaques de point d'écoute SAILMAN  
/ For use with the SAILMAN range of headboards and clew plates

Réf.	Matériau	Ø.	Haut.	Réf. Matrice
D037N	Laiton Nickel	16	16	C321
D038N	Laiton Nickel	19	19	C322
D039N	Laiton Nickel	22	19	C323
D039S	Inox 316L	22	19	C323

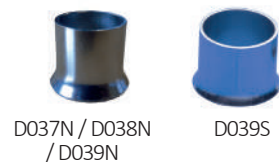

### //// Matrice pour cosse tête / Matrix to lug headboard

881850	Pour cosse tête 115
881880	Pour cosse tête 135 et 160
C321	Pour cosse D037N
C322	Pour cosse D038
C323	Pour cosse D039N & D039S



881850/ 881880



C321/ C322/ C323

## Œillets / Grommets

### Œillets "Endeavour" inox 316L / "Endeavour" Stainless steel Grommets 316L

Spécifiquement conçus pour utilisation sur : Tissus à voiles (polyester et composite) et PVC (industrie, voile d'ombrage). Résistance et durabilité maximales. Très bon maintien. Gamme d'outils pour le montage et démontage.

*/ Specifically designed for use on: Sailing fabrics (polyester and composites) and PVC (industry, shade sails). Maximum strength and durability. Very good support. Range of tools for assembly and disassembly.*

Réf.	Dimensions		Force & Load Data			
	Int. Ø	PerforationØ	Press on dies	Yield force	Max load	Matrices
828099	10 mm	11 mm	1,5 T/by hand	150 kg	310 kg	828109
828098	12 mm	13 mm	1,8 T/by hand	320 kg	660 kg	828108
828100	14 mm	15 mm	2,5 T/by hand	860 kg	1780 kg	828110
828101	20 mm	22 mm	10 T	790 kg	2520 kg	828111
828102	25 mm	28 mm	15T	1250 kg	3340 kg	828112

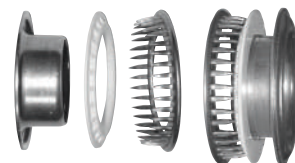

### Œillets renforcés BAINBRIDGE & cosses / Inox Pressed Rings

Cosse inox 316L + nylon / 316L stainless steel thimble + nylon

Réf.	Ø du trou	Couleur	Réf.	Ø du trou	Couleur
D208B	10	Noir	D210N	20	Bleu
D208N	10	Bleu	D210R	20	Rouge
D207B	12	Noir	D211B	25	Noir
D207N	12	Bleu	D211N	25	Bleu
D207R	12	Rouge	D211R	25	Rouge
D209B	15	Noir	D212B	30	Noir
D209N	15	Bleu	D212N	30	Bleu
D209R	15	Rouge	D213B	35	Noir
D209W	15	Blanc	D214B	40	Noir
D210B	20	Noir			



### Œillets SAILMAN / SAILMAN Rings

Réf.	Dimensions		Force & Load Data			
	Int. Ø	PerforationØ	Press on dies	Yield force	Max load	Matrices
D530	30	32	20	1500	5800 kg	CD530
D535	35	38	22	1800	6970 kg	CD535
D545	45	47	25	3030	9310 kg	CD545
D555	55	57	30 - 2 stage	3200	15050 kg	CD555



CD530 -> CD555

### ////// Cœillets à griffe / Toothed grommets

Cœillets en laiton nickelé. Livrés complets (rivures et contre-rivures).  
/ Nickel-plated brass grommets. Come complete (riveting, riveting and cons).

Réf./1000 p.	Réf./100 p.	Appellation	Ø int.	Ø ext.	Jeu Réf. Inox	jeu de pose	Jeu de pose Inox	Emporte pièce
D001	880958	N000	5 mm	10 mm		881458		829030
D002	880959	N00	7 mm	14 mm		881459		829040
D003	880960	N0	8 mm	17 mm	880962	881460		829050
D004	880970	N1	10 mm	19 mm	880972	881470	881470I	829060
D005	880980	N2	11,5 mm	22 mm	880982	881480	881480I	829070
D006	880990	N3	12,5 mm	25 mm	880992	881490	881490I	829070
D007	881000	N4	15 mm	28 mm	881002	881500		829080
D008	881010	N5	17 mm	33 mm	881012	881510		829090
D009	881020	N6	20 mm	38 mm		881520		829100



Jeu de pose

### ////// Cœillets à griffe Stimpson / Stimpson spur - Toothed grommets

Gamme d'œillets laiton nickelé de qualité supérieure, laiton plus épais & meilleure qualité de griffes.  
/ The higher strength of these spur-toothed grommets derives from their thicker metal gauge and flange closing.

Réf.	Taille	Ø (mm)	Jeu de pose STIMPSON	Outil de découpe avec conditionnement
D003NS	0	6,4	Solid Brass / Nickel	Pack 144
D004NS	1	9,5	Solid Brass / Nickel	Pack 144
D005NS	2	10,3	Solid Brass / Nickel	Pack 144
D006NS	3	11,1	Solid brass / Nickel	Pack 144
D007NS	4	14,2	Solid Brass / Nickel	Pack 144
D008NS	5	15	Solid Brass / Nickel	Pack 144
D009NS	6	17,4	Solid Brass / Nickel	Pack 144

Outil de fermeture perfo. Stimpson	Outil de fermeture Eco	Perforation	Taille	Ø du trou (mm)	Ø (mm)
C303S	C303C	C106	0	6,4	9,5
C304S	C304C	C107	1	7,9	11,1
C305S	C305C	C108	2	9,4	12,7
C306S	C306C	C109	3	11,1	14,3
C307S	C307C	C110	4	12,7	15,9
C308S		C111	5	15,8	17,5
C309S		C114	6	19,1	22,2



C306C

C106

### ////// Cœillets à bêche / Tarpaulin grommets

Cœillets en laiton nickelé. Livrés complets (rivures et contre-rivures).  
/ Nickel plated brass grommets. Come complete (riveting, riveting and cons)

Réf.	Appellation	Ø int.	Ø ext.	Jeu de pose
880004	N30	6	12	880530
880005	N32	8	17	880540
880000	N33	11	21	880500
880010	N34	15,5	30	880510
880015	N35	15,5	30	880515



## Triangle / Anneau D & ombrage / Triangle / D-Ring & awning

### ////// Triangles inox barrés 316L / 316L Stainless steel triangle with bar

Ferrures en acier inox avec barrette inox soudée. Permet un bon maintien de la sangle et une meilleure rigidité de l'ensemble.

/ Fitting in stainless steel with welded stainless steel strip. Allows a good hold of the strap and a better rigidity of the whole.

Réf.	Appellation	Ø int.	Résistance
804000	FPE6	6 mm	2700 kg
804010	FPE8	8 mm	4700 kg



### ////// Triangles inox 316 / Stainless Steel 316 Triangle

Réf.	Appellation	Dimensions	Résistance
804005	Triangle Inox	40 x 6 x 60°	2000 kg
804006	Triangle Inox	50 x 6 x 60°	2700 kg
804008	Triangle Inox	50 x 8 x 60°	4700 kg



### ////// Anneaux inox en D / D ring

Réf.	Ø fil	Larg.	Haut.
804192	3	18 mm	20 mm
804193	5	23 mm	25 mm
804194	6	37 mm	30 mm
804195	6	47 mm	50 mm



### ////// Anneaux ombrage / Shading rings

Réf.	Désignation	D	A	L	H
804196	Anneaux en D - ombrage 5 x 50	5 mm	50 mm	58	8
804197	Anneaux en D - ombrage 8 x 52	28 mm	52 mm	60	13

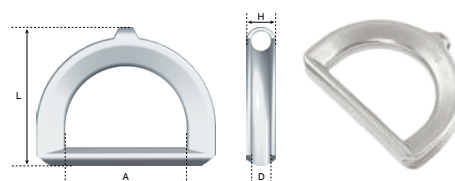

### ////// Anneaux soudés inox 316L / 316L Round ring

Soudure haute qualité **TIG®**. Finition polissage électrolytique et passivation / High quality **TIG®** welding. Electrolytic polishing and passivation

Réf.	Désignation	A	B	C.T kg	C.R kg
804098	Anneau Inox 3 x 15	3 mm	15 mm	300	750
804099	Anneau Inox 4 x 20	4 mm	20 mm	500	1250
8040995	Anneau Inox 4 x 25	4 mm	25 mm	500	1250
804100	Anneau Inox 4 x 30	4 mm	30 mm	500	1250
804110	Anneau Inox 4 x 40	4 mm	40 mm	500	1250
804120	Anneau Inox 5 x 30	5 mm	30 mm	700	1750
804125	Anneau Inox 5 x 40	5 mm	40 mm	700	1750
804140	Anneau Inox 6 x 30	6 mm	30 mm	1100	2750
804145	Anneau Inox 6 x 40	6 mm	40 mm	1100	2750
804150	Anneau Inox 6 x 50	6 mm	50 mm	1100	2750
804155	Anneau Inox 8 x 40	8 mm	40 mm	1900	4750
804160	Anneau Inox 8 x 50	8 mm	50 mm	1900	4750
804165	Anneau Inox 10 x 60	10 mm	60 mm	2780	6950
804166	Anneau Inox 10 x 50	10 mm	50 mm	2780	6950

C.T=charge de travail (swl)

C.R=charge de rupture (bl)

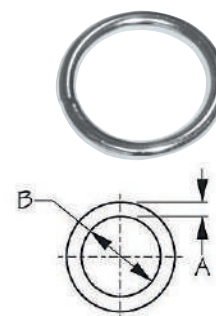

## Anneaux inox soudés & barrés / Welded & barred stainless steel rings

### ////// Anneaux inox soudés barrés / Maxi rings

Réf.	Ø fil	Larg. (mm)	Résistance	Réf.	Ø fil	Larg. (mm)	Résistance
804168	6	30	2980 kg	804175	10	40	5605 kg
804170	8	50	5000 kg	804178	10	50	8000 kg
804172	8	40	5080 kg	804180	10	60	8500 kg



### ////// Anneaux inox 316L soudés BAINBRIDGE / Stainless steel - Round rings

Avec soudure TIG afin de renforcer la résistance.  
Les anneaux de petit diamètre avec le même diamètre de fil se déformeront avant la rupture bien qu'ils aient la même résistance.

TIG welded maximizing strength.  
Small diameter rings with the same size bar diameter will deform at a higher load, although both will have similar tensile strength.



Réf.	Ø intérieur	Ø fil	Charge (kg)	Réf.	Ø intérieur	Ø fil	Charge (kg)
B204	25 mm	3	150	B219	40 mm	8	750
B214	25 mm	5	300	B121	45 mm	8	900
B118	30 mm	5	300	B228	30 mm	8	1000
B119	40 mm	6	400	B221	50 mm	9	1000
B117	30 mm	6	600	B229	40 mm	9	1300
B227	25 mm	6	800	B225	50 mm	11	750
B220	50 mm	8	550				



### ////// Anneaux inox 316L soudés barrés BAINBRIDGE / Stainless steel - Maxi rings

Avec soudure TIG afin de renforcer la résistance.  
La barre renforcée réduit la possible déformation sous des charges importantes.

TIG welded maximizing strength.  
Reinforcing bar reduces potential distortion under high load.

Réf.	Ø intérieur	Ø fil	Charge (kg)
B229B	38 mm	9,3	2600
B225BB	38 mm	9,3	4000
B225B	51 mm	11.1	4000
B226BB	51 mm	11.1	4500
B226B	64 mm	12.7	4500
B218B	76 mm	15,8	10000



B229/5/6/18B

### ////// Anneaux de voile inox 316L AQUABATTEN / Stainless steel - Sail rings

Plus léger & plus résistant qu'un anneau équivalent soudé.  
Fabrication en fonte qui élimine le point faible de la soudure.  
Section transversale elliptique et barre de renforcement qui augmentent la rigidité.

Lighter and stronger than conventional equivalent welded rings.  
Cast construction eliminates weld weak point.  
Elliptical cross-section and strengthening bar increases stiffness.



Réf.	Taille (mm)	Charge (kg)
B248	74 x 58 x 9,3 x 6,4	2000
B250	92 x 72 x 10,5 x 7,2	3000



## Ferrures - Anneaux - Cosse / Fitting - Ring - Thimble

### ////// Cosses cœurs barrées inox 316L / Reinforced Stainless steel Thimbles

Cosses cœurs barrées soudées pour gennaker, code0,... Application sur cordage épissé, câble anti-torsion.  
Soudure haute qualité. Finition polissage électrolytique et passivation / Rod-coated corrugated lugs for gennaker, code0, ...  
Application on spliced rope, anti-torsion cable. High quality welding. Electrolytic polishing and passivation.

Réf.	Désignation	Dim.A	Dim.B	Dim.C	Cndt.
620026	Cosse Cœur Barrées Soudées Ø 06	36 mm	12 mm	8 mm	x10
620028	Cosse Cœur Barrées Soudées Ø 08	44 mm	14 mm	11 mm	x10
620030	Cosse Cœur Barrées Soudées Ø 10	56 mm	18 mm	13 mm	x10
620032	Cosse Cœur Barrées Soudées Ø 12	66 mm	22 mm	17 mm	x10
620034	Cosse Cœur Barrées Soudées Ø 14	76 mm	24 mm	20 mm	x10
620036	Cosse Cœur Barrées Soudées Ø 16	78 mm	26 mm	21 mm	x10
620038	Cosse Cœur Barrées Soudées Ø 18	88 mm	28 mm	24 mm	x10

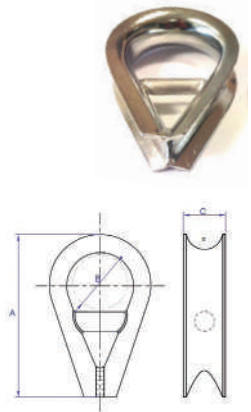

### ////// Cosses cœurs arrondies / Stainless steel thimbles

En acier inoxydable / Stainless steel

Réf.	Ø	Réf.	Ø
610002	Ø 2	610006	Ø 6
610003	Ø 3	610008	Ø 8
610004	Ø 4	610010	Ø 10
610005	Ø 5	610012	Ø 12



### ////// Cosses cœurs barrées fonderie / Welded thimbles

630006	Ø 6
630008	Ø 8
630010	Ø 10
630012	Ø 12
630014	Ø 14

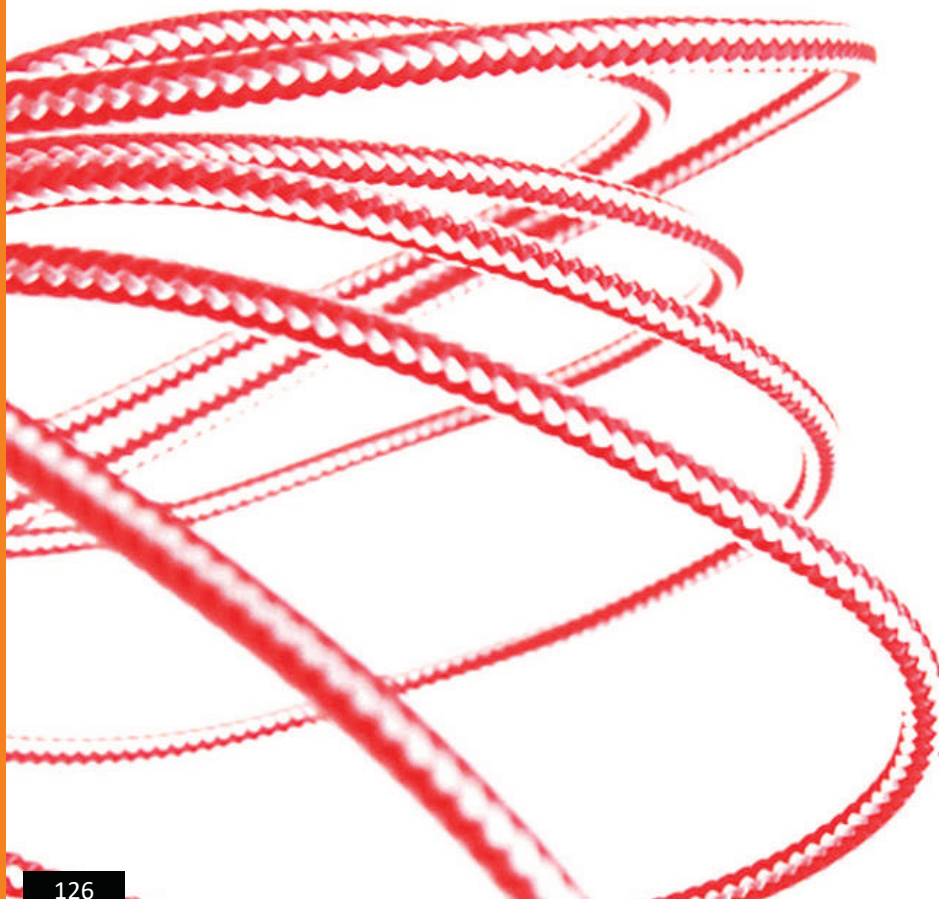

## Poulies et anneaux à friction / Blocks and friction rings

### ////// Poulie à cordon / Cord pulley

Pour ferlage, serrage de housse

840487

Avec réa



### ////// Poulie point d'écoute Alu / Aluminium Clewblock Sheave Outhaul

Joue & Réa en aluminium anodisé, roulement à billes Delrin® / Anodized aluminum cheek & sheave, Delrin® ball bearing

Réf.	Ø poulie	Ø cordage	Charge maxi	Passage de sangle
803529	40	10	700 kg	30 mm
803530	50	12	900 kg	30 mm
803535	70	16	4000 kg	30 mm
803537	100	20	6000 kg	30 mm



Ensemble destiné au foc monotype (cata de sport, melges, ...) / Design for sportsboats, small catamarans

Réf.	Ø poulie	Ø cordage	Charge maxi	Passage de sangle
B0903V	100	16	2500 kg	45 mm
B0902V	76	14	1200 kg	35 mm



### ////// Poulie + anneaux inox / Sportsboat clew ring

Ensemble destiné au foc monotype (cata de sport, melges, ...).  
/ Design for sportsboats, small catamarans

804191

Poulie + anneau inox 5 x 30



### ////// Anneaux Aluminium 6082T6 / Aluminium Friction Ring 6082T6

Anodisé dur Noir, finition Teflon / Hard anodized Black, Teflon finish

Réf.	Désignation/ Items	Ø
804625	Anneau Friction Alu Noir 25 x 10	Ø7
804635	Anneau Friction Alu Noir 35 x 15	Ø10
804650	Anneau Friction Alu Noir 50 x 20	Ø15
804670	Anneau Friction Alu Noir 70 x 28	Ø20



Réf.	D1	D2	Ø	T	SWL kg	gr
804625	10 mm	25 mm	7 mm	12 mm	800	5
804635	15 mm	35 mm	10 mm	15 mm	1500	10
804650	20 mm	50 mm	15 mm	25 mm	3500	40
804670	28 mm	70 mm	20 mm	30 mm	6200	110

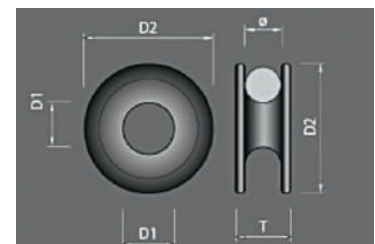

## Rails & joints pour capotes / Rails & rubber seals

### ////// Rails pour ralingue / Rope rail

Longueur : 5 m

840158	Rail Alu Brut
840159	Rail Alu anodisé

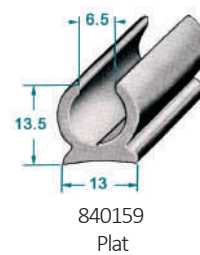
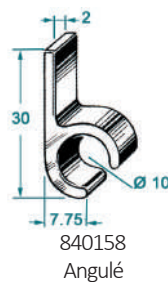

### ////// Rails pour ralingue BAINBRIDGE / BAINBRIDGE Awning & Sprayhood Track



G512	Rail Plastique Flexible Blanc - 300 cm
G512BK	Rail Plastique Flexible Noir - 300 cm
G513	Rail Plastique Renforce - 243 cm
G520-8	Rail Alu - 244 cm

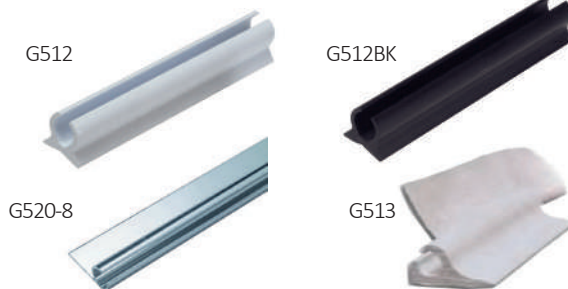

### ////// Joints BAINBRIDGE / BAINBRIDGE Extreme Seals

Fabriqués à partir d'extrusion de mousse de caoutchouc, adaptés à toute application avec besoin de joint étanche. Section en "P" assure une étanchéité optimale. Vendu au rouleau.

*Manufactured from foam rubber extrusion, suitable for any application requiring a tight seal. P-Section design ensures maximum efficiency. Full roll only.*

L705BKA	Joint Autocollant Noir - 34 mm - RI 75 m
L710BK	Joint Noir - 44 mm - RI 15 m





## Accastillages bimini - capote / Fittings bimini - hood

### //// Embouts pour tube / Canopy eye ends and plugs

840172	Embout Pour Tube 25 mm
G631SHD	Embout Pour Tube 25 mm Aquamarine
840173	Embout Pour Tube 25 mm
840174	Embout Pour Tube 30 mm



G631SHD



840172

### //// Colliers pour tube / Canopy Janw and Hinge Slides

840169	Collier Pour Tube 25 mm
840175	Collier Pour Tube 30 mm
840176	Collier Séparable Tube 25 mm
840177	Collier Séparable Tube 30 mm
G630SHD	Collier Pour Tube 25 mm Heavy Duty Aquamarine
G830S	Collier Séparable Tube 25 mm Aquamarine



840169



G630SHD



G820S



G830S

### //// Platines / Canopy Deck fittings

840160	Platine de Pont avec Axe à Visser
840161	Platine Angulé avec Axe à Visser
G626S	Platine de Pont Concave Axe Rapide
840163	Platine Standard avec Axe Rapide
840164	Platine Angulé avec Axe Rapide
840166	Platine à Fixation Verticale
840179	Platine de Pont Universelle à Vis
G615S	Platine de Pont Universelle avec Vis Aquamarine
G615SQP	Platine Universelle avec Goupille Aquamarine
G625PIN	Goupille Rapide
G605S	Platine de Pont Orientable / Escamotable Aquamarine



840161



840160



G6055



G625PIN



G615SQP



G615S



G758

### //// Connecteur de tube & clip / Tubing Hinge Quick Release

G744S	Connecteur Tube de 25 mm Goupille Aquamarine
G758	Clip Gemlock



G744S

### //// Ridoirs bimini / Bimini turnbuckles

840151	Ridoir Bimini Tube 25 mm
840152	Ridoir Bimini Tube 30 mm



840151

## Sandows - Boucles - Œillets à coudre - Passants / Bungees - Buckles - Sewing eyelets

### //// Sandows / Bungees cords

Câble élastique en polyester. Couleur écru ou noir. Vendu par rouleau de 100 m  
 / Polyester shock cord. Colour: natural or black. 100 m full roll only

Réf. Blanc / white	Désignation/ Items	Réf. Noir / Black	Désignation/ Items
827950	Sandow 4 mm MI	827950N	Sandow Noir 4 mm MI
827955	Sandow 5 mm MI	827955N	Sandow Noir 5 mm MI
828000	Sandow 6 mm MI	828000N	Sandow Noir 6 mm MI
828010	Sandow 8 mm MI	828010N	Sandow Noir 8 mm MI
828020	Sandow 10 mm MI	828020N	Sandow Noir 10 mm MI

Réf. Gris / Gray	Désignation/ Items
828020G	Sandow 10 mm MI



### //// Elastiques plats / Flat elastic roll

Elastiques pour gousset de latte. Couleur écru. Rouleau de 100 m. / Batten pocket elastic. Colour: Raw. Roll of 100 m

Réf.	Largeur
828395	8 mm
828410	25 mm
828415	40 mm
E551	Elastique Plat 19 mm
E552	Elastique Plat 25 mm



### //// Embouts basculants / Tipping tips

Permet la fixation à travers un œillet. / Allows the attachment through an eyelet

Réf.	Largeur
828035	5 mm
828036	6 mm
828037	8 mm



### //// Pince à sertir / Crimping tool

C449	Pince à sertir pour agrafes inox
B450	Agrafes Inox (x100)



C449

B450

### //// Bouton de laçage de taud / Lacing buttons

800093	Standard	Nylon	Blanc
800193	Standard	Nylon	Noir
800199	Ø 12 x 10	Inox	Vis Ø 3



18,4 mm

### //// Crochet de laçage / Lacing hook

800192	Noir
800092	Blanc

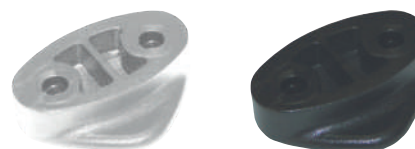

## //// Passants / Tenax

### L> Passants sangle Nylon / Nylon webbing bridge

Réf.	Noire	Mm entre axe
800180	Blanc 25 mm	39
800180N	Noir 25 mm	39
800181	Blanc 50 mm	59
800181N	Noir 50 mm	59



### L> Passant sangle inox / bridge à la place de strap fitting

Réf.	G	L	B
800200	25	50	15

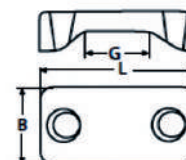

## //// Mousqueton inox à passage de sangle / Stainless steel swivel snap hook for webbing

Réf.	A	B	L	S
805025	25	37	65	10

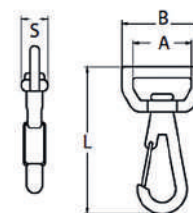

## //// Mousqueton inox à émerillon / Stainless steel swivel eye snap

Réf.	C	B	L	BL/Kg
805016	16	21	117,5	350



## //// Boucle inox / Stainless steel adjustable buckle

### L> Double passant 50 mm / Double 50 mm sliding

Réf.	A	B	C	S	L
841403	50 mm	62 mm	6 mm	3 mm	62 mm

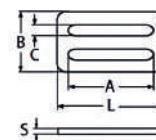

### L> À rouleau 25 mm / Sliding bar buckle 25 mm

Réf.	A	B
841410	25	25



## Sandows - Boucles - Cœillets à coudre / Bungees - Buckles - Sewing eyelets

### ////// Boucles mixtes inox / plastiques / Plastic / Stainless steel sliding bar buckle

Largeur de sangle / Webbing width

841400	20/25 mm
841401	40/45 mm
841402	50/55 mm



### ////// Boucles plastiques / PLadderlock Buckle

Largeur de sangle / Webbing width

Réf. Noir*	Réf. Blanc**	Largeur
840400	840401	20 mm
840402	840403	25 mm
840405	840406	30 mm
840407	840404	40 mm



840401



840400

### ////// Boucles de réglage / Adjustable buckles

Largeur de sangle / Webbing width

840440	30 mm
840450	40 mm
840453N	50 mm / Noir*

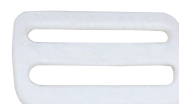

840440



840453N

### ////// Boucles sangles super / Strong ladderlock buckle

Boucles super. En plastique noir, pour les sangles de fortes épaisseurs. Très résistantes. Largeur de sangle / Super buckle. Black plastic for the straps of thick very strong. Webbing width

840411	20 mm
840412	25 mm

**YKK®**



### ////// Boucles à came / Cam buckles

Largeur de sangle / Webbing width

840409	25 mm
840410	30 mm
840426	40 mm
840408	50 mm



### ////// Attache-rapide / Snap buckles

Largeur de sangle / Webbing width

Réf. Blanc**	Réf. Noir*	Largeur
840424	X	10 mm
840420	840423	20 mm
840421	840422	25 mm
840425	840427	30 mm
X	840429	40 mm
X	840433	50 mm

**YKK®**



\*Black - \*\*White

### //// Crochets pour sandows 2 pièces / Shockcord fittings

828030	Ø 6 Noir*
828034	Ø 8 Noir*



### //// Petit crochet pour sandows / Small hook for bungee cords

828028	Ø 4 - Ø 6 Blanc**
--------	-------------------



### //// Gros crochets pour sandows / Large hook for bungee cords

828029N	Ø 5 - Ø 6 Noir*
828031	Ø 7 - Ø 8 Blanc**
828032	Ø 4 - Ø 5 Blanc**
828032N	Ø 4 - Ø 5 Noir*



### //// Crochets pour taud / Cover brackets

Réf.	Type	Hauteur	Largeur	Ø fil	Ø int.
804480	A visser °	16 mm	29 mm	6 mm	6 mm
804481	A riveter °	24 mm	12 mm	8 mm	8 mm
840485	A coudre °	51 mm	38 mm	8 mm	8 mm
840486	Ceil à coudre °	51 mm	38 mm	6 mm	8 mm



A068BK	Ceillets Plastique à Coudre - Noir* - Aquabatten
A068WT	Ceillets Plastique à Coudre - Blanc** - Aquabatten
A069BK	Crochets Plastique à Coudre - Noir* - Aquabatten
A069WT	Crochets Plastique à Coudre - Blanc** - Aquabatten



### //// Bloqueur cordon / Cord Blocker

Réf.	Ø	Couleur
840431	4 mm	Blanc**
840431N	4 mm	Noir*
840432	5 mm	Blanc**
840432N	5 mm	Noir*



### //// Crochet pneumatique gris / Grey inflatable hook

Réf.	Désignation	A	B	C	D	E	F	G
840414	Crochet Nylon Gris***	39,5	40	22,5	15	4	45°	7

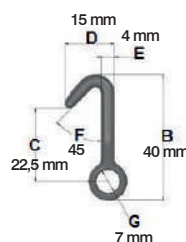
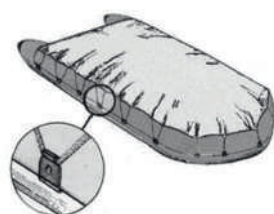

\*Black - \*\*White - \*\*\* Nylon grey hook

° To screw - To rivet - To sew - Sewing eye

## Sandows - Boucles - Œillets à coudre / Bungees - Buckles - Sewing eyelets

### ////// Anneaux plastiques / Plastic rings

Réf.	Type	∅ int.	∅ ext.	∅ fil
804410	ANP-18	18 mm	32 mm	7 mm
804420	ANP-20	22 mm	30 mm	5 mm
804440	ANP-29	27 mm	47 mm	9 mm



### ////// Œillet attache-rapide "Holdon" / Holdon clips

Système d'accroche ré-utilisable / Attachment system reusable

828038	Œillet Holdon "Mini"
828039	Œillet Holdon "Midi"



### ////// Plaque de sangle nylon / Nylon strap plate

Épaisseur 5 mm / Thickness 5 mm

800069	Blanc <sup>2</sup> - 50 mm
800069N	Noir <sup>1</sup> - 50 mm

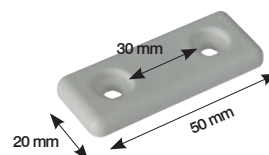

### ////// Boules plastiques / Plastic balls

Réf.	Quantité	Couleur	∅ cordage	Diamètre
840416	x 5	Couleurs	5 mm	PM ∅ 16
840416B	x 10	Blanche <sup>2</sup>	5 mm	PM ∅ 16
840416N	x 10	Noir <sup>1</sup>	5 mm	PM ∅ 16
840416R	x 10	Rouge <sup>3</sup>	5 mm	PM ∅ 16
840416V	x 10	Vert <sup>4</sup>	5 mm	PM ∅ 16
840416M	x 10	Bleu <sup>5</sup>	5 mm	PM ∅ 16

Réf.	Quantité	Couleur	∅ cordage	Diamètre
840417	x 5	Couleurs	6 mm	MM ∅ 20
840417B	x 10	Blanche <sup>2</sup>	6 mm	MM ∅ 20
840417N	x 10	Noir <sup>1</sup>	6 mm	MM ∅ 20
840417R	x 10	Rouge <sup>3</sup>	6 mm	MM ∅ 20
840417V	x 10	Vert <sup>4</sup>	6 mm	MM ∅ 20
840417M	x 10	Bleu <sup>5</sup>	6 mm	MM ∅ 20



Réf.	Quantité	Couleur	∅ cordage	Diamètre
840413	x 5	Couleurs	7 mm	GM ∅ 31
840413B	x 10	Blanche <sup>2</sup>	7 mm	GM ∅ 31
840413N	x 10	Noir <sup>1</sup>	7 mm	GM ∅ 31
840413R	x 10	Rouge <sup>3</sup>	7 mm	GM ∅ 31
840413V	x 10	Vert <sup>4</sup>	7 mm	GM ∅ 31
840413M	x 10	Bleu <sup>5</sup>	7 mm	GM ∅ 31

Réf.	Quantité	Couleur	∅ cordage	Diamètre
840419	x 5	Couleurs	11 mm	XLM ∅ 40
840419B	x 10	Blanche <sup>2</sup>	11 mm	XLM ∅ 40
840419N	x 10	Noir <sup>1</sup>	11 mm	XLM ∅ 40
840419R	x 10	Rouge <sup>3</sup>	11 mm	XLM ∅ 40
840419V	x 10	Vert <sup>4</sup>	11 mm	XLM ∅ 40
840419M	x 10	Bleu <sup>5</sup>	11 mm	XLM ∅ 40

### ////// Butées plastiques / Plastic stops

Réf.	Couleur	Diamètre
840650R	Rouge <sup>3</sup>	40 x 10
840650GR	Vert <sup>4</sup>	40 x 10
840651R	Rouge <sup>3</sup>	60 x 12
840651GR	Vert <sup>4</sup>	60 x 12



<sup>1</sup>Black - <sup>2</sup>White - <sup>3</sup>Red - <sup>4</sup>Green - <sup>5</sup>Blue

# Fixations et pressions / Fixings and pressures

## //// Bouton pression / Button snap fasteners

SYSTÈME DE FIXATION RAPIDE POUR TAUDS, BÂCHES, CAPOTES, ... / MOUNTING SYSTEM FOR QUICK AWNINGS, TARPS, TOPS, ...

### ↳ Partie femelle / Female part

840462	2 éléments laiton nickelé	2 components nickel plated brass
840452	2 éléments inox	2 components stainless steel

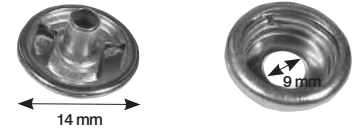

### ↳ Partie mâle / Male part

840461	2 éléments laiton nickelé	2 components nickel plated brass
840451	2 éléments inox	2 components stainless steel



### ↳ Partie mâle Vis Parker / Male screw part Parker

840458	Pression mâle
--------	---------------



### ↳ Outil de pose / Hand setting tools

881435	Outil de pose
--------	---------------



## //// Tourniquet / Common sense Turn button Fasteners

### ↳ Système de fixation tissu/rigide robuste et esthétique / Fastening system fabric / strong, rigid and aesthetic

Laiton nickelé / Nickel plated brass

840479	Partie mâle, petite hauteur	17 mm hauteur	Male, small height
840478	Partie mâle, hauteur standard	20 mm hauteur	Male, standard height
840481	Partie mâle, grande hauteur	22 mm hauteur	Male big height
840580	Tourniquet titan	Simple hauteur 24	Common sense turn botton fastener



### ↳ Jeu de pose tourniquet / Common sense turn botton setting tool

881430	Jeu de pose
881432	Jeu de pose pour tourniquet TITAN



### ↳ Œillet oval pour tourniquet / Oval eyelet for common sense turn button

840483	A pose mécanique	For mechanical setting
840482	A pose manuelle	Manual setting
840582	Œillet oval fendu titan + contre-rivure	Oval eyelet + Clinch plate

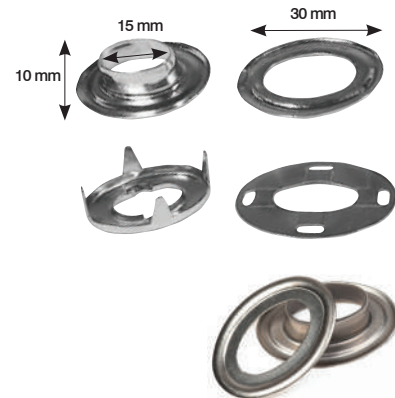

## Fixations et pressions / Fixings and pressures

### ////// Tourniquet / Common sense Turn button Fasteners

#### L> Emporte-pièce pour tourniquet / Cutter & Setting for fasteners

829190 Oval  
 829190A Emporte pièce ovale à arche

829190



829190A



829191 Oval, à pose manuel



### ////// Fermeur Fix / Regular socker

SYSTÈME DE FIXATION TISSU/RIGIDE. EN MÉTAL NICKELÉ, ÉCONOMIQUE ET SIMPLE D'UTILISATION.  
 / FABRIC ATTACHMENT SYSTEM / RIGID. NICKEL-PLATED METAL, ECONOMICAL AND EASY TO USE.

#### L> Fermeur fix / Regular prongs

840491 Fermeur Fix



#### L> Partie mâle à vis / Stud with stainless steel screw

840492 Vis Parker Fasteners stud



#### L> Partie mâle à boulonner / Stud with machine brass screw

840493 Partie mâle à boulonner Male part to be bolted

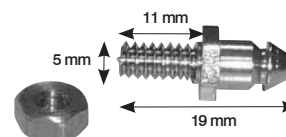

### ////// Minax / Minax

SYSTÈME TISSU/RIGIDE VERROUILLABLE, EN MATIÈRE PLASTIQUE BLANCHE  
 / FABRIC SYSTEM / RIGID LOCKABLE, WHITE PLASTIC

#### L> Partie femelle / Female part

840515 Partie femelle Female part



#### L> Partie mâle / Male part

840516 Minax Partie mâle Vis Inox Male part  
 840517 Minax Partie mâle Plastique Male part







## Fixations et pressions / Fixings and pressures

### //// Tenax

Système tissu / rigide très fiable, finition de qualité / Fabric system / rigid highly reliable, high quality finish

#### ↳ Partie femelle / Standard pull top wilock washer

840511                      Partie femelle                      *Female part*



#### ↳ Partie mâle vis tole 1 / Sheet metal screws male part 1

840513                      Partie mâle vis tole 1                      *Male part screw*



#### ↳ Partie mâle à boulonner / Male part to be bolted

840512                      Partie mâle à boulonner                      *Male part to be bolted*



#### ↳ Partie mâle à platine / 2 screw stud

840514                      Partie mâle à platine                      *Male part plate*



### Loxx



#### ↳ Petite clé pour Loxx / Small Loxx wrench

840505      LOXX clé métal Tenax



#### ↳ Clé manche bois pour Loxx / Wooden stick Loxx wrench

840506      LOXX clé bois Tenax

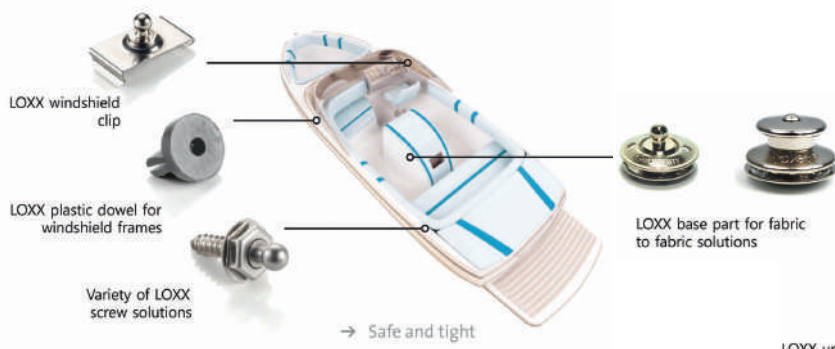

//// LOXX



↳ **Partie femelle tête large / Large head Female part only**

840511LL	Laiton	Brass
840511LC	Chrome	Chrome
840511LI	Inox Hybrid	Hybrid Stainless



↳ **Partie Mâle à boulonner / Male part to be bolted**

840512LL	Laiton M5 x 10	Brass
840512LC	Chrome M5 x 11	Chrome
840512LI	Inox M5 x 12	Stainless steel



840508 Ecrou M5

↳ **Partie Mâle à visser / Male part to be screwed**

840513LL	Laiton 10 mm	Brass
840513LC	Chrome 10 mm	Chrome
840513LI	Inox 10 mm	Stainless steel
840518LL	Laiton 16 mm	Brass
840518LC	Chrome 16 mm	Chrome



↳ **Platine Partie Mâle / Platinum male part**

840514LL	Laiton	Brass
840514LC	Chrome	Chrome



↳ **Embase Partie Mâle / Lower male part**

840519LL	Laiton - Tissu	Brass - Fabric
840519LC	Chrome - Tissu	Chrome - Fabric



↳ **Collier de fixation Inox / Fastener stainless steel collar**

840525L	Tube Ø22
840526L	Tube Ø25
840527L	Tube Ø30



Accastillage / Sailmaking hardware

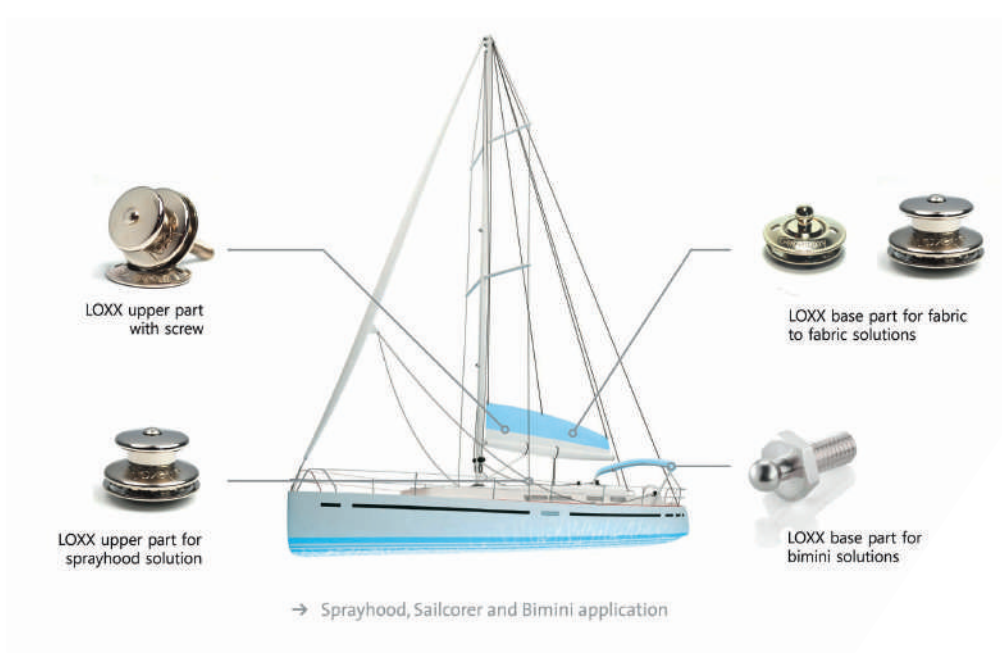

## Fixations et pressions / Fixings and pressures



### Pressions DOT

Réf.	Désignation
840458D	Pression Mâle Dot Vis Parker 10934
840459D	Pression Dot Boule Pare Brise 3/4 10388
840460D	Pression Dot Boule Pare Brise 7/8 10391
840470D	Pression Dot Laiton Calotte 10128
840471D	Pression Dot Laiton Cuvette 10224
840472D	Pression Dot Laiton Boule à Sertir 10370
840473D	Pression Dot Laiton Boule Creuse 10379
840474D	Pression Dot Laiton Contre Rivure 10412
840470Di	Pression Dot Inox Calotte 10128
840471Di	Pression Dot Inox Cuvette 10224
840472Di	Pression Dot Inox Boule à Sertir 10370
840474Di	Pression Dot Inox Contre Rivure 10412
840475D	Tourniquet Dot à Griffe 78332
840476D	Tourniquet Dot à Griffe 78332 Avec C/Rivure
840479D	Tourniquet Dot Simple Hauteur 78322
840478D	Tourniquet Dot Double Hauteur 78323
840482D	Œillet Dot Ovale à Griffe 78403
840483D	C/Rivure Dot 78510 Pour Ovale à Griffe
840484D	Œillet Dot Ovale à Griffe 78403 Avec C/Rivure
840489D	Safety Dot Calotte 16205
840490D	Safety Dot C/Rivure 16506
840491D	Safety Dot Calotte 16205 Avec C/Rivure 16506
840492D	Safety Dot Boule à Vis 16360
840494D	Safety Dot Boule Sur Platine 16347
829190	Emp Piece Ovale Pour Tourniquet
829191	Emp Piece Pour Œillet Ovale à Pose Manuelle
881430	Jeu De Pose Tourniquet
881431	Presse à Main Dot Snapmaster 89-M840
881431-1	Outil Presse Main Snapmaster 840470
881431-2	Outil Presse Main Snapmaster 840471
881431F	Jeu de Pose à Frapper Pression Dot



### Tourniquet / Turnbuckle

#### ↳ Emporte-pièce pour tourniquet / Punch to turnbuckle

Réf.	Désignation
829190	Oval
829190A	Emporte pièce ovale à arche

Réf.	Désignation
829191	Oval, à pose manuel
829192	Oval, à Frapper pour Œillet Titan



#### ↳ Jeu de pose tourniquet / Set of poses tourniquet

Réf.	Désignation
881430	Jeu de pose

## //// YKK SNAD

SNAD et FLEXSNAD s'adaptent à toutes les surfaces lisses et propres : verre, plastique, PVC, métal sans trace de solvant...  
Grâce à l'adhésif 3MTM VHBTM le collage est parfait après 48-72h de polymérisation. Nettoyer préalablement le support à l'alcool.

*/SNAD and FLEXSNAD adapt to all smooth and clean surfaces: glass, plastic, PVC, metal without trace of solvent ...*

*Thanks to the adhesive 3MTM VHBTM the bonding is perfect after 48-72h of polymerization. Clean the substrate beforehand with alcohol.*

Réf.	Désignation	Nature	Couleur
840550	SNAD YKK	40 Femelle/socket	White
840551	SNAD YKK	40 Femelle/socket	Black
840552	SNAD YKK	40 Male/socket	White
840553	SNAD YKK	40 Male/stud	Black

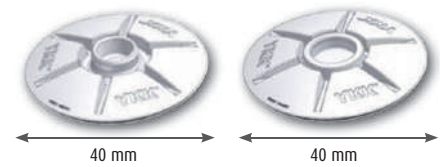

## //// YKK SNAD flexible

Réf.	Désignation	Nature	Couleur
840554	SNAD YKK	25 Male/stud	White
840555	SNAD YKK	25 Male/stud	Black
840556	SNAD FLEX YKK	25 Male/stud	White
840557	SNAD FLEX YKK	25 Male/stud	Black
840558	SNAD FLEX YKK	25 Male/stud	Transparent

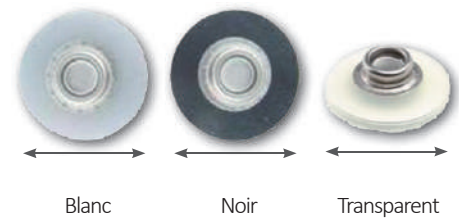

## //// Pression plastique STAYPUT / STAYPUT plastic pressure

Réf.	Désignation
840465B	Stayput Blanc Chapeau
840466B	Stayput Blanc Douille
840467B	Stayput Blanc Support
840465N	Stayput Noir Chapeau
840466N	Stayput Noir Douille
840467N	Stayput Noir Support
881436	Pince Stayput



### YKK fermetures plastiques séparables / Plastic YKK open ended

#### ↳ Fermetures plastiques injectées séparables YKK5 / YKK5 Séparable injected plastic fasteners

Réf.	Largeur	Longueur	Couleur
824136-6	6 mm	0,20 m	Blanc <sup>2</sup>
824136-6N	6 mm	0,20 m	Noir <sup>1</sup>
824138-6	6 mm	0,25 m	Blanc <sup>2</sup>
824138-6N	6 mm	0,25 m	Noir <sup>1</sup>
824137-6	6 mm	0,30 m	Blanc <sup>2</sup>
824137-6N	6 mm	0,30 m	Noir <sup>1</sup>
824130	6 mm	0,50 m	Blanc <sup>2</sup>
824130N	6 mm	0,50 m	Noir <sup>1</sup>
824139-6	6 mm	0,60 m	Blanc <sup>2</sup>
824139-6N	6 mm	0,60 m	Noir <sup>1</sup>
824131	6 mm	0,80 m	Blanc <sup>2</sup>
824127	6 mm	1 m	Blanc <sup>2</sup>
824127N	6 mm	1 m	Noir <sup>1</sup>
824127G	6 mm	1 m	Gris <sup>3</sup>
824135N	6 mm	1,30 m	Noir <sup>1</sup>
824128	6 mm	1,50 m	Blanc <sup>2</sup>
824128N	6 mm	1,50 m	Noir <sup>1</sup>

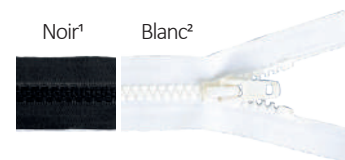

Réf.	Largeur	Longueur	Couleur
824129	6 mm	2 m	Blanc <sup>2</sup>
824129N	6 mm	2 m	Noir <sup>1</sup>
824129G	6 mm	2 m	Gris <sup>3</sup>
824132N	6 mm	2 m	Noir <sup>1</sup>
824131N	6 mm	2,80 m	Noir <sup>1</sup>
824132	6 mm	3 m	Blanc <sup>2</sup>
824133	6 mm	5 m	Blanc <sup>2</sup>
824134	6 mm	8 m	Blanc <sup>2</sup>

#### ↳ Fermetures plastiques injectées séparables YKK10 / YKK10 Séparable injected plastic fasteners

Réf.	Largeur	Longueur	Couleur
824136	9 mm	0,20 m	Blanc <sup>2</sup>
824136N	9 mm	0,20 m	Noir <sup>1</sup>
824138	9 mm	0,25 m	Blanc <sup>2</sup>
824138N	9 mm	0,25 m	Noir <sup>1</sup>
824137	9 mm	0,30 m	Blanc <sup>2</sup>
824137N	9 mm	0,30 m	Noir <sup>1</sup>
824046	9 mm	0,40 m	Blanc <sup>2</sup>
824046N	9 mm	0,40 m	Noir <sup>1</sup>
824047	9 mm	0,50 m	Blanc <sup>2</sup>
824047N	9 mm	0,50 m	Noir <sup>1</sup>
824139	9 mm	0,60 m	Blanc <sup>2</sup>
824139N	9 mm	0,60 m	Noir <sup>1</sup>
824048	9 mm	0,80 m	Blanc <sup>2</sup>
824048N	9 mm	0,80 m	Noir <sup>1</sup>
824048CG	9 mm	0,80 m	Cadet Grey
824049	9 mm	1 m	Blanc <sup>2</sup>
824049N	9 mm	1 m	Noir <sup>1</sup>
824049NV	9 mm	1 m	Navy
824049D	9 mm	1 m	Dune
824049B	9 mm	1 m	Beige
824049G	9 mm	1 m	Gris <sup>3</sup>
824049T	9 mm	1 m	Taupe
824050	9 mm	1,20 m	Blanc <sup>2</sup>
824050N	9 mm	1,20 m	Noir <sup>1</sup>
824050B	9 mm	1,20 m	Beige <sup>4</sup>
824050CG	9 mm	1,20 m	Cadet Grey
824051	9 mm	1,30 m	Blanc <sup>2</sup>

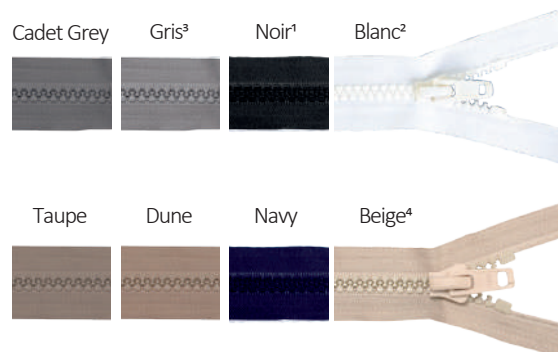

Réf.	Largeur	Longueur	Couleur
824054	9 mm	1,40 m	Blanc <sup>2</sup>
824054N	9 mm	1,40 m	Noir <sup>1</sup>
824055	9 mm	1,50 m	Blanc <sup>2</sup>
824055N	9 mm	1,50 m	Noir <sup>1</sup>
824055NV	9 mm	1,50 m	Navy
824055B	9 mm	1,50 m	Beige
824055CG	9 mm	1,50 m	Cadet Grey
824055CR	9 mm	1,50 m	Crème <sup>5</sup>
824055D	9 mm	1,50 m	Dune
824055G	9 mm	1,50 m	Gris <sup>3</sup>
824055T	9 mm	1,50 m	Taupe
824056	9 mm	1,60 m	Blanc <sup>2</sup>

<sup>1</sup>Black - <sup>2</sup>White - <sup>3</sup>Grey - <sup>4</sup>Natural - <sup>5</sup>Cream

## ↳ Fermetures plastiques injectées séparables YKK10 / YKK10 Séparable injected plastic fasteners

Réf.	Largeur	Longueur	Couleur
824056N	9 mm	1,60 m	Noir <sup>1</sup>
824056CG	9 mm	1.60 m	Cadet Grey
824058	9 mm	1,80 m	Blanc <sup>2</sup>
824058N	9 mm	1,80 m	Noir <sup>1</sup>
824058CG	9 mm	1.80 m	Cadet Grey
824060	9 mm	2 m	Blanc <sup>2</sup>
824060N	9 mm	2 m	Noir <sup>1</sup>
824060NV	9 mm	2 m	Navy
824060B	9 mm	2 m	Beige <sup>4</sup>
824060D	9 mm	2 m	Dune
824060G	9 mm	2 m	Gris <sup>3</sup>
824060CG	9 mm	2 m	Cadet Grey
824062	9 mm	2,20 m	Blanc <sup>2</sup>
824065	9 mm	2,50 m	Blanc <sup>2</sup>
824065D	9 mm	2,50 m	Dune
824065N	9 mm	2,50 m	Noir <sup>1</sup>
824065NV	9 mm	2,50 m	Navy
824065B	9 mm	2,50 m	Beige <sup>4</sup>
824065G	9 mm	2,50 m	Gris <sup>3</sup>
824065CG	9 mm	2.50 m	Cadet Grey
824068	9 mm	2,80 m	Blanc <sup>2</sup>
824068N	9 mm	2,80 m	Noir <sup>1</sup>
824068CG	9 mm	2.80 m	Cadet Grey
824070	9 mm	3 m	Blanc <sup>2</sup>
824070N	9 mm	3 m	Noir <sup>1</sup>
824070Nv	9 mm	3 m	Navy
824070B	9 mm	3 m	Beige <sup>4</sup>
824070D	9 mm	3 m	Dune
824070G	9 mm	3 m	Gris <sup>3</sup>
824075	9 mm	3,50 m	Blanc <sup>2</sup>
824075N	9 mm	3,50 m	Noir <sup>1</sup>
824075T	9 mm	3.50 m	Taupe
824080	9 mm	4 m	Blanc <sup>2</sup>
824080N	9 mm	4 m	Noir <sup>1</sup>
824085	9 mm	4,50 m	Blanc <sup>2</sup>
824085N	9 mm	4,50 m	Noir <sup>1</sup>
824087	9 mm	5 m	Blanc <sup>2</sup>
824087N	9 mm	5 m	Noir <sup>1</sup>

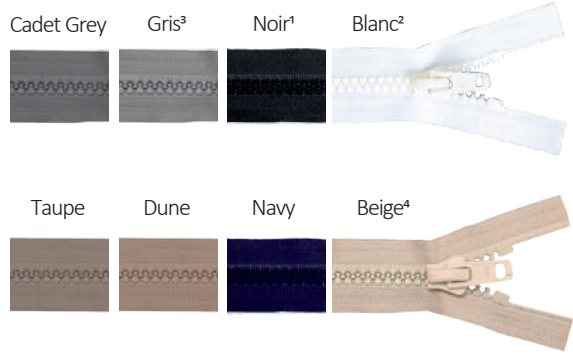

Réf.	Largeur	Longueur	Couleur
824088	9 mm	5,50 m	Blanc <sup>2</sup>
824090	9 mm	6 m	Blanc <sup>2</sup>
824090N	9 mm	6 m	Noir <sup>1</sup>
8240905	9 mm	6,50 m	Blanc <sup>2</sup>
824095	9 mm	7 m	Blanc <sup>2</sup>
824095N	9 mm	7 m	Noir <sup>1</sup>
824098	9 mm	8 m	Blanc <sup>2</sup>
824098N	9 mm	8 m	Noir <sup>1</sup>
824099	9 mm	9 m	Blanc <sup>2</sup>
824100	9 mm	11 m	
824105	9 mm	12 m	
824106	9 mm	13 m	
824120	9 mm	15 m	
824125	9 mm	16 m	
824126	9 mm	18 m	
824126N	9 mm	18 m	Noir <sup>1</sup>
824126-20	9 mm	20 m	Blanc <sup>2</sup>
824099-22	9 mm	22 m	Blanc <sup>2</sup>
824099-24	9 mm	24 m	Blanc <sup>2</sup>
824126-25N	9 mm	25 m	Noir <sup>1</sup>
824126-26	9 mm	26 m	Blanc <sup>2</sup>
824126-26N	9 mm	26 m	Noir <sup>1</sup>

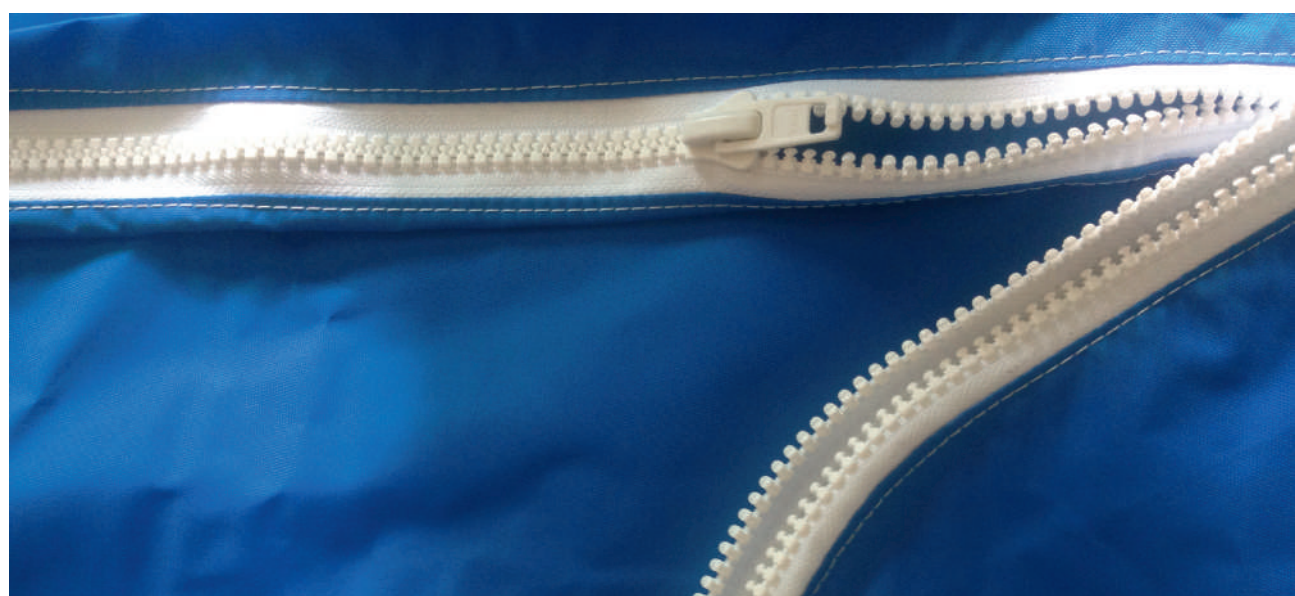

<sup>1</sup>Black - <sup>2</sup>White - <sup>3</sup>Grey - <sup>4</sup>Natural - <sup>5</sup>Cream

## Fermetures YKK / YKK Zip



### //// Fermetures plastiques injectées séparables 15 mm curseur inox / Plastic closures injected separable 15 mm stainless steel sliders

Réf.	Désignation	Largeur	Tirette	Longueur
824030	Fermeture Injectée Séparable	15 mm	curseur inox	L 4 m
824031	Fermeture Injectée Séparable	15 mm	curseur inox	L 6 m
824032	Fermeture Injectée Séparable	15 mm	curseur inox	L 8 m
824033	Fermeture Injectée Séparable	15 mm	curseur inox	L 10 m
824034	Fermeture Injectée Séparable	15 mm	curseur inox	L 12 m



### //// Fermeture plastique continue YKK / YKK Plastic continuous zipper

Réf.	Désignation	Largeur	Couleur	Longueur
824002	Fermeture Injectée Continue	6 mm	Blanc	RI x100 m
824002N	Fermeture Injectée Continue	6 mm	Noir	RI x100 m
824005	Fermeture Injectée Continue	9 mm	Blanc	RI x100 m
824005N	Fermeture Injectée Continue	9 mm	Noir	RI x100 m
824020	Fermeture Injectée Continue	15 mm	Blanc	RI x100 m
824024	Fermeture YKK Continue Spirale	3 mm	Blanc	RI x200 m
824035	Fermeture YKK Continue Spirale	6 mm	Blanc	RI x100 m
824035N	Fermeture YKK Continue Spirale	6 mm	Noir	RI x100 m
824017	Fermeture YKK Continue Spirale	9 mm	Blanc	RI x100 m
824017N	Fermeture YKK Continue Spirale	9 mm	Noir	RI x100 m
824023	Fermeture PK Continue Spirale	19 mm	Blanc	RI x10 m





### ////// Curseurs pour fermetures injectées / Sliders for injected closures

Réf.	Désignation	Largeur	Couleur
823900	Curseur plastique double tirette	6 mm	Blanc
823900N	Curseur plastique double tirette	6 mm	Noir
824003	Curseur plastique simple tirette	6 mm	Blanc
824003N	Curseur plastique simple tirette	6 mm	Noir
824010	Curseur plastique double tirette	9 mm	Blanc
824010N	Curseur plastique double tirette	9 mm	Noir
824010G	Curseur Double Tirette	9 mm	Gris
824010N	Curseur Double Tirette	9 mm	Noir
824015	Curseur plastique simple tirette	9 mm	Blanc
824015N	Curseur plastique simple tirette	9 mm	Noir
824014	Curseur métal simple tirette	9 mm	
824009	Curseur métal double tirette	9 mm	
824011	Curseur métal traite mer		
824022	Curseur inox	15 mm	
824028	Curseur plastique	15 mm	Blanc



### Curseurs pour fermetures spirales / Sliders for injected closures

Réf.	Désignation	Largeur	Tirette	Couleur
824018	Curseur Métal	9 mm	Simple Spiralee	
824019	Curseur Métal	9 mm	Double Spiralee	
824021	Curseur Plastique	3 mm	Simple Spiralee	Blanc
824037	Curseur Plastique	6 mm	Simple Spiralee	
824037-P	Curseur Spirale Simple	6 mm	Plastique	Blanc
824037D	Curseur Spirale Double	6 mm		
824037DN	Curseur Spirale Double	6 mm		Noir
824037N	Curseur Spirale Simple	6 mm		Noir
824037N-P	Curseur Spirale Simple	6 mm	Plastique	Noir



### Arrêts / Stops / Stops

Réf.	Désignation	Largeur	Couleur
824004	Arrêt Haut	6 mm	Blanc
824004N	Arrêt Haut	6 mm	Noir
824016	Arrêt Haut	9 mm	Blanc
824016N	Arrêt Haut	9 mm	Noir



### Arrêt haut inox / Stainless steel stop

Pour Zipp YKK maille 9 mm (chaîne de 10) / For Zipp YKK 9 mm mesh (chain of 10)

Réf.	Désignation
824029	Arrêt haut inox 9 mm (x 100)



## Auto-agrippant / Velcro Hook and Loop



### Auto-agrippant autocollant / Velcro sticker

Ruban auto-agrippant adhésif blanc. Longueur : 25 m / Velcro tape adhesive white. Length: 25 m

Réf. Blanc	Taille	Type		Réf. Noir
825019	20 mm	Crochet	Hook	825019N
825020	20 mm	Velours	Loop	825020N
825021	25 mm	Crochet	Hook	825021N
825022	25 mm	Velours	Loop	825022N
825023	30 mm	Crochet	Hook	825023N
825024	30 mm	Velours	Loop	825024N
825025	50 mm	Crochet	Hook	825025N
825026	50 mm	Velours	Loop	825026N
825017	40 mm	Crochet	Hook	825017N
825018	40 mm	Velours	Loop	825018N



### Disques velcro / Velcro discs

Disques auto-agrippants semi rigides blancs / Velcro discs semi rigid white

Réf. Blanc	Ø en mm	Type		Réf. Noir
825011	Ø 45 mm	Velours	Loop	825011N
825012	Ø 45 mm	Crochet	Hook	-
825013	Ø 25 mm	Velours	Loop	-
825014	Ø 25 mm	Crochet	Hook	825014N



### Disque crochet plastique / Crochet plastic discs

Disque rigide 45 mm à riveter / Hard disc 45 mm riveting

Réf. Blanc	Ø en mm	Type		Réf. Noir
825010	Ø 45 mm	Crochet	Hook	825010N



### Auto agrippant à coudre / Velcro to sew

Ruban auto-agrippant standard blanc (autres couleurs et autres largeurs à la demande). Longueur : 25 m / Velcro tape standard white (other colors and other widths on request). Length: 25 m

Réf. Blanc	Taille	Type		Réf. Noir
825000	25 m x 20 mm	Crochet	Hook	825000N
825001	25 m x 20 mm	Velours	Loop	825001N
825002	25 m x 25 mm	Crochet	Hook	825002N
825003	25 m x 25 mm	Velours	Loop	825003N
825004	25 m x 30 mm	Crochet	Hook	825004N
825005	25 m x 30 mm	Velours	Loop	825005N
825006	25 m x 50 mm	Crochet	Hook	825006N
825007	25 m x 50 mm	Velours	Loop	825007N
825008	25 m x 40 mm	Crochet	Hook	825008N
825009	25 m x 40 mm	Velours	Loop	825009N
825015	25 m x 100 mm	Crochet	Hook	825015N
825016	25 m x 100 mm	Velours	Loop	825016N



## Lattes acryliques constantes / Acrylic batten constant

### //// Lattes plates vinylester / Flat vinylester battens

Lattes en fibres de verre et résine acrylique, à épaisseur constante. Couleur : gris clair.  
 / Batten with glass fibers and acrylic resin, a uniform thickness. Color : light grey.

Réf.	Largeur <sup>1</sup>	Epaisseur <sup>2</sup>	Longueur <sup>3</sup>
835000	9 mm	2.5 mm	6 m
835010	15 mm	2.5 mm	6 m
835012	15 mm	4.5 mm	6 m
835018	18 mm	2 mm	6 m
835030	30 mm	3 mm	6 m
835035	30 mm	4 mm	6 m
835036	30 mm	6 mm	6 m
835040	40 mm	3 mm	6 m
835045	40 mm	4 mm	6 m



### → Lattes jonc vinylester / Rod vinylester battens

Réf.	∅	Longueur <sup>3</sup>
836095	6 mm	6 m
836100	8 mm	6 m
836110	10 mm	6 m
836112	12 mm	6 m
836114	14 mm	6 m
836116	16 mm	6 m
836126	16 mm	7 m
836118	18 mm	7 m
836118-6	18 mm	6 m
836128	18 mm	9 m
836120	20 mm	9 m
836124	20 mm	8 m
836130	20 mm	10 m
836125	24 mm	8 m



<sup>1</sup>Width - <sup>2</sup>Thickness - <sup>3</sup>Length

## Lattes acryliques constantes / Acrylic batten constant

### ////// Lattes plates SAILMAN / Pultruded flat battens



Réf.	Largeur <sup>1</sup>	Epaisseur <sup>2</sup>	Longueur <sup>3</sup>
15CT	15 mm	3 mm	6 m
15CTST	15 mm	4 mm	6 m
16HCP	16 mm	6 mm	6 m
30CT024	30 mm	2 mm	6 m
30CT031	30 mm	3 mm	6 m
30CT031R	30 mm	3 mm	30 m
30CT044	30 mm	4 mm	6 m
30CT044R	30 mm	4 mm	30 m
30CT052	30 mm	5 mm	6 m
30CT052R	30 mm	5 mm	30 m
40CT	38 mm	3 mm	6 m
40CTST	38 mm	5 mm	6 m

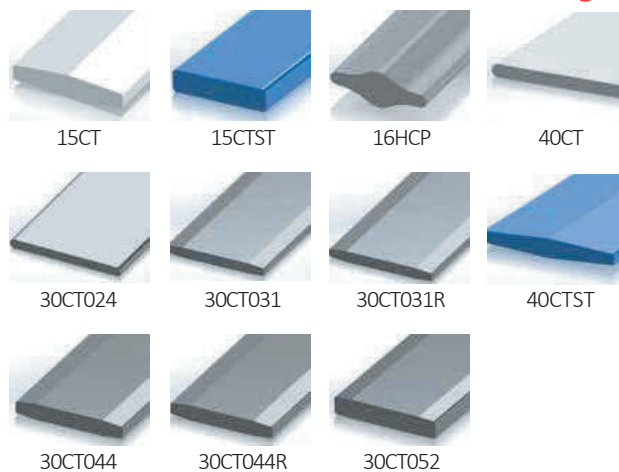

### ////// Lattes jonc SAILMAN / Pultruded rod battens roll

Réf.	∅	Rouleau <sup>4</sup>
06R30	6 mm	30 ml
08R30	8 mm	30 ml
10R30	10 mm	30 ml



### ////// Lattes plates vinylester / Pultruded vinylester battens

Qualité Supérieure Vinylester. Couleur Grise / High quality Vinylester construction. Color : light grey.

Réf.	Largeur <sup>1</sup>	Epaisseur <sup>2</sup>	Longueur <sup>3</sup>
20CV062	20 mm	6 mm	12 m
20CV080	20 mm	8 mm	12 m
20CV107	20 mm	11 mm	12 m
20CV125	20 mm	12 mm	12 m

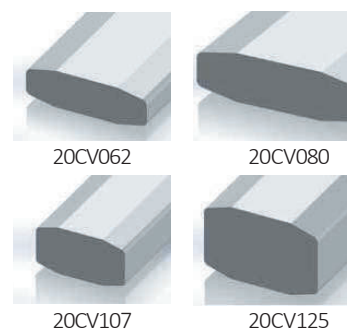

### ////// Lattes plates vinylester SAILMAN / Pultruded sailman batten

Pultrusions en vinylester de haute qualité offrant une ténacité ultime pour les applications exigeantes de lattes pleines.

La forme du profil résiste aux "serpents", tout en offrant un grand gain de poids.

Ils présentent une plage de rigidité logique et progressive.

Le tout dans une largeur commune de 30 mm.

High quality vinylester pultrusions delivering ultimate tenacity for demanding full batten applications.

Profile shape resists 'snaking', whilst offering weight saving aloft.

They feature a logical and progressive range of stiffness.

All in a common 30 mm width.

Réf.	Largeur <sup>1</sup>	Epaisseur <sup>2</sup>	Longueur <sup>3</sup>
U30063	30 mm	6,3 mm	12 m
U30076	30 mm	7,6 mm	12 m
U30102	30 mm	10,2 mm	12 m
U30114	30 mm	11,4 mm	12 m
U30127	30 mm	12,7 mm	12 m

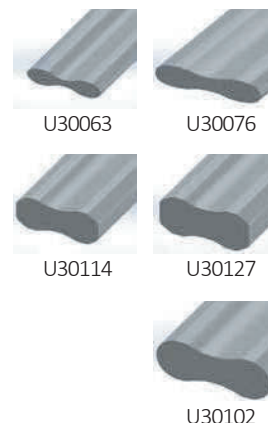

/// Pdf gamme lattes profilées AQUABATTEN sur demande / AQUABATTEN profiled slats range Pdf on request.



<sup>1</sup>Width - <sup>2</sup>Thickness - <sup>3</sup>Length - <sup>4</sup>Roll



## Embouts & butée latte / Acrylic batten constant



### Butée de latte BAINBRIDGE / Batten pocket protectors

Réf.	∅	Rouleau
A000	15 mm	Rivet
A001	15 mm	Vis
A002	30 mm	Vis
A004	30 mm	Rivet
A005	60 mm	Vis
A006	40 mm	Boulon/écrou
A302	30 mm	Vis



### Embouts lattes plates BAINBRIDGE / Endcaps for flat battens

Réf.	Utilisation avec lattes <sup>2</sup>	Profondeur <sup>3</sup>
10DXSTECI	L402000750300G10 L406001251400G10	10 mm
10DECO	L402000750300G10 L406001251400G10	10 mm
10DECI	L402000750300G10 L406001251400G10	10 mm
10EC002	Aquabatten 10 mm	10 mm
15EC002	Aquabatten 15 mm	19 mm
15CTECI	15CT	20 mm
15CTECO	15CT	20 mm
15DXSTECIBK	15CTST/16HCP	20 mm
15DXSTECIWT	15CTST/16HCP	20 mm
15DNECI	L402000750300G15 L406001251400G15	18 mm
15DNECO	L402000750300G15 L406001251400G15	18 mm
20DEC006	20CV062/80 Aquabatten 20 mm	23 mm
20DEC010	20CV107/125 Aquabatten 20 mm	23 mm
25CTJM	25NTM	28 mm
30CEC	30CT024/30CT031	35 mm
30CTEC	30CT044/30CT052	35 mm
40CEC	40CT/40CTST	42 mm
A150	16HCP	28 mm



<sup>1</sup>Roll - <sup>2</sup>Batten connection - <sup>3</sup>Depth

### //// Embouts PVC guindant et chute / PVC luff & leech tip ends

885378	10 mm pour latte dériveur raide
885380	8 mm pour latte dériveur



### //// Embouts souples / Flexible tips ends

Pour lattes plates / For flat batten

840009	9 mm
840010	15 mm
840020	20 mm
840030	30 mm
840040	40 mm
840050	50 mm



### //// Embouts latte jonc pour guindant ou chute / Luff & leech round patten tip ends

840114	Embout Latte Jonc Nylon Rec	Ø 6
840115	Embout Latte Jonc Nylon Rec	Ø 8
840116	Embout Latte Jonc Nylon Rec	Ø 10
840117	Embout Latte Jonc Nylon Rec	Ø 12
840118	Embout Latte Jonc Nylon Rec	Ø 14
840119	Embout Latte Jonc Nylon Rec	Ø 16



### //// Embouts de lattes jonc / Rod tip ends

#### /// Plastique / Plastic

840131	Ø 8
840132	Ø 10
840134	Ø 12
840136	Ø 14
840138	Ø 16



#### /// Aluminium / Aluminium

840140	Ø 6
840141	Ø 8
840142	Ø 10
840143	Ø 12
840144	Ø 14
840145	Ø 16
840146	Ø 18
840147	Ø 20

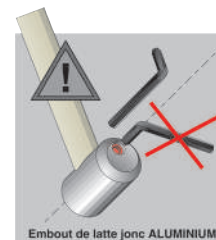

## Tube carbone - Butées de latte / Carbon tube - Batten pocket protectors

### //// Tube carbone / Carbon tube

Fréquemment utilisés pour la réalisation de cerf-volants, ces tubes en carbone se caractérisent par une grande légèreté et une résistance exceptionnelle.

*/ Frequently used for making kites, these carbon tubes are characterized by low weight and exceptional strength.*

836156	Ø extérieur 6 mm	2 m de longueur
836160	Ø extérieur 8 mm	2 m de longueur
836162	Ø extérieur 10 mm	2 m de longueur



### //// Butées de latte plastique / Flat batten ends

840210	Butée latte 15 mm
840207	Butée de latte PAV 30 mm
840205	Butée de latte CATA 50 mm



### //// Butées de latte plate avec passage de sangle / Flat batten ends for webbing

840206	Butée latte 25/30 mm avec passage de sangle
840208	Butée latte 40 mm avec passage de sangle à visser
840208T	Butée latte 40 mm avec passage de sangle à boulonner

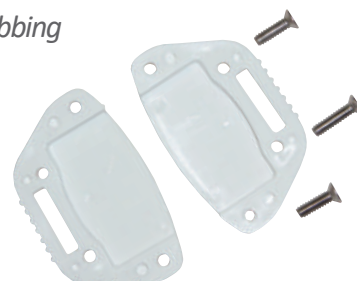

### //// Butées de latte épaisse avec passage de sangle / Batten plate cases for webbing

800143	Butée latte à sangler latte 30 x 06 mm
800212	Butée latte à sangler latte 25 x 10 mm
800155	Butée latte à sangler latte 10 x 20 mm





### ////// Butées de latte BAINBRIDGE / BAINBRIDGE end fittings

Réf.	Largeur <sup>3</sup> Max. Latte	
A300BK	30 x 6.5	Passage de sangle
A300WT	30 x 6.5	Passage de sangle
A303BK	45 x 7	Passage de sangle ou manille B303
A303WT	45 x 7	Passage de sangle ou manille B303

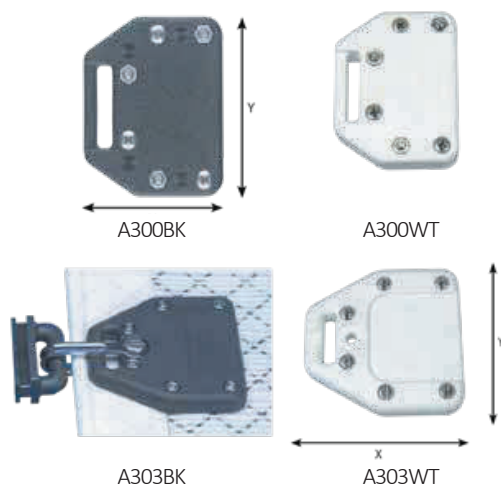

### ////// Manille / Shackle for attachment

Réf.	Longueur <sup>2</sup>	Largeur <sup>3</sup>
B303	42 mm	12 mm



Accastillage / Chandlery veils

## Boîtiers - Tendeur de latte / SDA batten fittings and Tensioners

### ////// Boîtiers SDA / SDA fittings for Battens

Fabriqués en nylon renforcé. Chaque boîtier est livré avec sa contre plaque & la visserie aluminium. Filetage M10 du boîtier de guindant.

*/ Made of reinforced nylon. Each box is delivered with its counter plate & aluminum screws. Luff housing M10 thread.*

Réf.	Dimensions	Type	Ø latte	
A4081	80 mm x 38 mm	Chute	jusqu'au 8 mm	Leech
A4082	80 mm x 38 mm	Guindant	jusqu'au 8 mm	Luff
A4122	65 mm x 50 mm	Guindant	10 & 12 mm	Leech
A4121	80 mm x 50 mm	Chute	11 & 12 mm	Luff
A4162	80 mm x 50 mm	Guindant	12 à 16 mm	Leech
A4161	80 mm x 50 mm	Chute	12 à 16 mm	Luff
A4202	100 mm x 50 mm	Guindant	16 à 20 mm	Leech
A4201	120 mm x 50 mm	Chute	16 à 20 mm	Luff

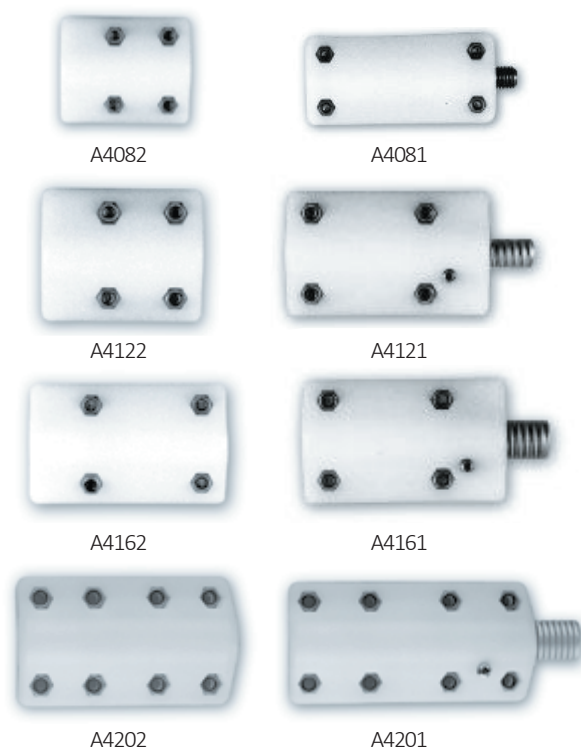

### ////// Vis de compression SDA / SDA batten fittings - Compression screws

Aluminium / Aluminum

Réf. Vis	Réf. Boîtier
A4121S	A4121
A4161S	A4161
A4201S	A4201



<sup>1</sup>Roll - <sup>2</sup>Width - <sup>3</sup>Length

## Boîtiers - Tendeur de latte / Case - Batten tension

### Boîtiers de latte jonc chute / Leech batten rod cases

Réf.	Désignation	Dim. LxIxH (mm)
800311	Boîtier Latte Jonc Chute Ø8-10	65 x 50 x 27
800312	Boîtier Latte Jonc Chute Ø12-14	80 x 50 x 32
800313	Boîtier Latte Jonc Chute Ø16	90 x 55 x 35



### Vis alu / Aluminum screws

Réf.	Désignation
800315	Vis Compression Alu M12 Boîtier 8-10 mm
800316	Vis Compression Alu M16 Boîtier 12-14 mm
800318	Vis Compression Alu M18 Boîtier 16 mm



### Boîtiers de latte jonc guindant / Luff batten rod cases

Réf.	Désignation	Dim. LxIxH (mm)
800306	Boîtier Latte Jonc Guindant Ø8-10 M10	65 x 50 x 27
800307	Boîtier Latte Jonc Guindant Ø12-14 M10	80 x 50 x 32
800308	Boîtier Latte Jonc Guindant Ø16 M10	90 x 55 x 35



### Boîtiers de latte plate / Batten plate cases

800162	Boîtier de latte PM réglable fixation M10 lattes 30 x 10 mm
800163	Boîtier de latte GM non réglable fixation M10 lattes 40 x 10 mm

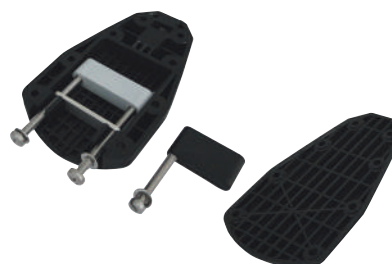

### Tendeurs de latte / Flat small tensioner

800286	Lattes 10.5 x 7 mm
800287	Lattes 16 x 7 mm
800288	Lattes 16 x 8 mm
800289	Lattes 20 x 10 mm



# Tendeurs de latte - Chariots - Manchons / Batten tension - Carriages - Sleeves

## Tendeurs de latte Hollow / Hollow Batten tensioner

885458	Tendeur de latte ø8 "rocket" long
885460	Clé
885461	Bougie
71910025	Vis

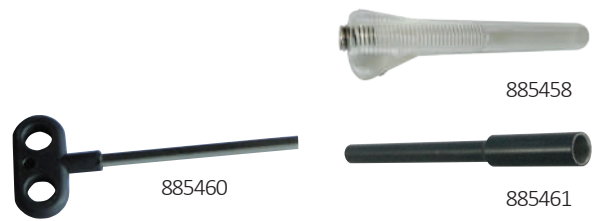

## Embout lashing / Lashing tips

Embout pour lattes jonc en Ertalyte® (PETP)0. Léger et résistant / Ertalyte® Battens (PETP) 0. Lightweight and durable

Réf.	Désignation	A	B	C	D
840121	Embout lashing latte jonc ø 8	12 mm	22 mm	40 mm	6 mm
840122	Embout lashing latte jonc ø 10	14 mm	25 mm	45 mm	7 mm
840123	Embout lashing latte jonc ø 12	18 mm	30 mm	55 mm	9 mm
840124	Embout lashing latte jonc ø 14	20 mm	40 mm	70 mm	10 mm
840125	Embout lashing latte jonc ø 16	22 mm	48 mm	80 mm	12 mm
840126	Embout lashing latte jonc ø 18	24 mm	55 mm	90 mm	18 mm

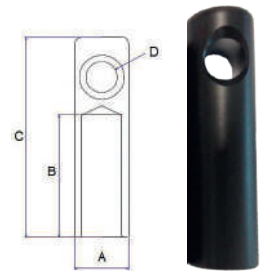

## Chariot "All Black" pour GV lattées / Stainless steel strit rod for reed batt

890000	Boitier de Latte Ø12 - Ø14 - 8 x 30 (tensioner)
890001	Car Batten C 11 W16
890002	Car Batten C 11 W18
890003	Car Batten C 14 W16
890004	Car Batten C 14 W18
890005	Car Batten C 17 W16
890006	Car Batten C 17 W18
890007	Car Batten C 20 W16
890008	Car Batten C 20 W18
890009	Car Batten C 23 W16
890010	Car Batten C 23 W18
890011	Articulation de Latte M10 x 20



## Manchon inox pour latte jonc / Stainless steel jonction for rod batten

Tube inox standard / Standard stainless steel tube  
Longueur 15 cm / Length 15 cm

840698	Ø intérieur 10
840699	Ø intérieur 12
840700	Ø intérieur 14
840701	Ø intérieur 16
840702	Ø intérieur 18
840703	Ø intérieur 20

Tube inox embouti avec butée / Stainless steel tube stamped with stopper  
Longueur 15 cm / Length 15 cm

840710	Ø intérieur 10
840712	Ø intérieur 12
840714	Ø intérieur 14



## Connecteur lattes jonc BAINBRIDGE / BAINBRIDGE Batten connectors

Acier inoxydable / Stainless steel

Réf.	Ø latte
BC08S	8 mm
BC10S	10 mm
BC12S	12 mm
BC14S	14 mm
BC16S	16 mm
BC20S	20 mm



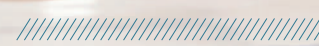

## Chaussettes à spi / Spinnaker socks

### Chaussettes à spi VMG / VMG spinnaker socks

Chaussettes à spi prête à l'emploi. Fabriquées en tissu maille polyester 115g.  
Livrées avec bol polyester ovale et fourreau extérieur.  
Disponible de 8 à 24 ml.

*/ Spinnaker sock ready to use. Made of polyester mesh fabric 115g.  
Comes with oval bowl polyester outer sheath.  
Available from 8 to 24 ml.*

**Longueur utile = longueur de la chute du spi + 50 cm**  
*Usefull lenght = spinnaker leech lenght + 50 cm*

Réf.	Longueur	Réf.	Longueur
832000	8 ml	832008	16 ml
832001	9 ml	832009	17 ml
832002	10 ml	832010	18 ml
832003	11 ml	832011	19 ml
832004	12 ml	832012	20 ml
832005	13 ml	832013	21 ml
832006	14 ml	832014	22 ml
832007	15 ml	832015	24 ml



### Avaleurs polyester / Polyester bowl

Réf.	Longueur
831215	40 m
831219	46 m
831217	55 m



### Couronne à spi / Polyester bowl

Réf.	Désignation	Rouleau
828420	Couronne sac à spi	25 ml



## Outillage et entretien / Tools and maintenance

### ////// Produit anti UV / Anti UV

Protection anti UV. Imperméabilisant (coutures, cartes marines, ...).  
/ UV protection. Waterproofing (stitching, charts, ...)

Réf.	Désignation	Cndt.
822555	SOROSUN	Bidon 5 litres



### ////// Produit d'entretien PVC / PVC Care Products

Réf.	Désignation	Cndt.
822560	Cleaner 500 Ferrari	500 ml
110528	Anti-moisissures MOISISTOP	1 litre
110875	Nettoyant Pvc/Skai Internet	500 ml



110875



110528



822560

### ////// Kit de nettoyage et de réimpermeabilisation / Kit of cleaning and waterproofing

Réf.	Désignation	Cndt.
965061	303 Fabric Cleaner	0,95 litre
965062	303 Fabric Guard	0,95 litre



TEX'AKTIV CLEAN



TEX'AKTIV GUARD

### ////// Dérouillant voile CLEANSAIL / Sail rust remover CLEANSAIL

Dérouillant à base d'acide phosphorique. CLEANSAIL enlève la rouille sur les voiles.  
Ne pas utiliser sur les spis.

/ Based on phosphoric acid. CLEANSAIL cleans and removes stains of rust, oil and grease from sails.  
Do not use on spinnaker type sail cloth.

Réf.	Cndt.
110750	500 ml
110760	1 litre



## ////// Entretien machine à coudre / Sewing machine maintenance

### L> Huile de vaseline / Vaseline oil

Huile d'entretien pour machine à coudre. / Maintenance oil for sewing machine

Réf.	Désignation
812848	Burette de 125 ml
812880	Bidon de 5 litres



## ////// Aiguilles et accessoires / Needles and accessories

### L> Aiguilles machine / Machine needles

Aiguilles convenant pour machine à coudre utilisant les systèmes : 265-438-SY8123. Pour tout autre système, nous consulter.  
/ Needles suitable for sewing machine using the systems: 2.65-438-SY8123. Any other system, consult us.

Réf.	Désignation
812990	AM60
813000	AM90
813010	AM100
813020	AM110
813030	AM120
813035	AM200

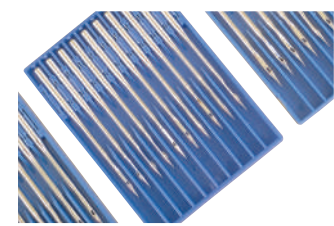

### L> Aiguilles à main / Hand needles

Réf.	Ø	Long. (mm)	Taille
C010	3.25	89	10
C012	2.64	81	12
C013	2.34	79	13
C014	2.03	76	14
C015	1.88	72	15
C016	1.63	69	16
C017	1.42	65	17
C018	1.22	62	18
C019	1.02	49	19



C010 - 19

### L> Assortiment aiguilles / Assorted needles

Deux AV16, deux AV17 et deux AV15. / Two AV16, two AV17 and two AV15.

Réf.	Désignation
813200	Tube de 6 aiguilles



## ////// Epissoir inox / Stainless marlin spike

Réf.	Désignation
816000	Petit modèle 170 mm
816010	Grand modèle 260 mm



## ////// Tube d'aiguilles à épisser / Stainless steel plicing set with hooks

Réf.	Désignation
ROB-7155097	Tube 5 aiguilles pour cordage 6 mm à 14 mm



## Outillage et entretien / Tools and maintenance

### ////// Paumelles / Hinges

#### ↳ Modèle standard / Standard model

814000	Droitier	Right
814010	Gaucher	Left



#### ↳ Gamme Bainbridge / Bainbridge model

C023	Droitier	Right
C024	Droitier	Right
C026	Droitier	Right
C027	Gaucher	Left
C028	Droitier	Right
C030	Droitier	Right
C032	Droitier	Right
C033	Gaucher	Left
C034	Droitier	Right
C036	Droitier	Right
C037	Gaucher	Left



C023



C024



C026 - 27



C028



C030



C032



C033



C034



C036



C037

### ////// Cuir de protection traité mer / Wed treated leather protection

Peau de fleur chromée, très résistante en milieu marin. Epaisseur environ 1.5 mm.  
/ Flower chrome skin, very resistant in the marine environment. Thickness: About 1.5 mm

806000	Cuir Protection Vache Au Dm 2 - Teint (Marron)
806001	Cuir Protection Vache Au Dm 2 - Non Teint (Gris)



### ////// Alène à vis / Awl screw

815020	Manche alène à vis
815025	Pointe ronde N60
815030	Pointe ronde N90





### ////// Ciseaux universels "Fiskars" / "Fiskars" scissors

101300	Longueur 21 cm, modèle droitier
101310	Longueur 21 cm, modèle gaucher



### ////// Ciseaux tailleur "Fiskars" / "Fiskars" tailors scissors

101320	Longueur 24 cm, modèle droitier
--------	---------------------------------



### ////// Ciseaux BAINBRIDGE / BAINBRIDGE scissors

Réf.	Qualité	Long. (mm)
C550-10	Standard	254
C550-12	Standard	305
C551-7	Industrie	178
C551-8	Industrie	203
C551-9	Industrie	229
C552-10	Usage Intensif	254
C552L-10	Usage Intensif	254
C552-12	Usage Intensif	305
C555-10	Supérieur	254
C555-12	Supérieur	305
C553	Pour le métal	
C554	Pour le plastique	



C550 - 10/12



C551 - 7/8/9/10



C552 - 10/L-10/12



C555 - 10/12

### ////// Ciseaux Dyneema® / Dyneema® scissors

ROB-7155379	Spécial fibres techniques
-------------	---------------------------



### ////// Alène manche plastique / Plastic handle awl

815010	Manche plastique
--------	------------------

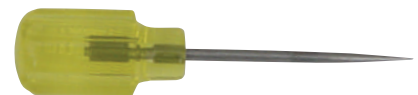

### ////// Push pin / Push pin

Tête plastique. Ø pointe 1 mm.

815111	Push pin
C903FP	Hot Pink



815111



C903FP

### ////// Punaises plastiques / Plastic bugs

815110	Punaises plastiques
--------	---------------------



### ////// Aiguille à long chas / Plastic bugs

L'aiguille à épisser des professionnels, convient pour tout type de cordage tressés. Réalisé en acier inoxydable avec poignée en plastique / The professional splicing needle, suitable for all types of braided ropes. Made of stainless steel with plastic handle

ROB-U130147	Jusqu'à 2 mm
ROB-U130151	2 - 4 mm



## Outillage et entretien / Tools and maintenance

### ////// Coupe fil Wiss / Wiss wire cutter

C554 Droitier / Gaucher



### ////// Elimeur "Fiskars" / "Fiskars" scissor tuner

101360 En blister



### ////// Genouillères / Knee pads

Genouillères avec système d'attache par sangles et velcro / Knee pads with attachment system for straps and velcro

828500 Renforcées



### ////// Découvit / Ripper

Equipé d'un bouchon de sécurité / Equipped with a safety cap

819000 Découvit Major  
C906 Découvit - Grand modèle



819000



C906

### ////// Briquet / Lighter

819005 En plastique blanc



### ////// Pince à tissu / Cloth clamps

Pour maintenir des matelas de tissu au découpage / To keep the mattress fabric cutting

C515R Pince à tissu 25 mm  
C516R Pince à tissu 50 mm  
C517R Pince à tissu 75 mm



### ////// Désagrafeuse / Staple remover

C519 Désagrafeuse



### //// Coupeur à chaud / Heat cutter

Fer de coupe, 60 watts de puissance nominale. L'appareil est prévu pour un travail intermittent. Alimentation 220 volts  
 / Cutting iron, 60 watts typical. The device is intended for intermittent work. Power 220 volts.

818000	Coupeur à chaud + lame
818010	Lame de rechange



### //// Coupeur à chaud sur batterie / Cordless heat cutter

ROB-7080216	Rechargeable
-------------	--------------



### //// Réglets inox / Reglets steel

Réglets flexibles, gradués sur les 2 faces / Reglets flexible, graduated on both sides.

820500	13 x 200 mm	820540	30 x 1000 mm
820510	13 x 300 mm	820560	30 x 2000 mm
820520	30 x 300 mm	820580	30 x 5000 mm
820530	30 x 500 mm		



### //// Double décimètre / Double tape measure

820000	Double décimètre ruban de 20 m
820010	Double décimètre métal 20 m



### //// Crayons / Pencils

ZMARKERWT	Marqueur lavable - Blanc
ZPENCILBU	Crayon effaçable - Bleu
ZPENCILW2	Crayon effaçable - Blanc



## Outillage et entretien / Tools and maintenance

### ////// Emporte-pièce à arche / Hole punches

Réf.	Modèle	Ø	Réf.	Modèle	Ø
829120	A20	20 mm	829137	A37	37 mm
829122	A22	22 mm	829138	A38	38 mm
829125	A25	25 mm	829140	A40	40 mm
829126	A26	26 mm	829145	A45	45 mm
829128	A28	28 mm	829148	A48	48 mm
829130	A30	30 mm	829150	A50	50 mm
829135	A35	35 mm	829160	A60	60 mm



### ////// Emporte-pièce simple / Single punch

Réf.	Modèle	Ø	Réf.	Modèle	Ø
829000	OL3	3 mm	829070	OL14	14 mm
829010	OL4	4 mm	829075	OL15	15 mm
829020	OL5	5 mm	829080	OL16	16 mm
829030	OL6	6 mm	829090	OL18	18 mm
829040	OL8	8 mm	829100	OL20	20 mm
829050	OL10	10 mm	829102	OL22	22 mm
829060	OL12	12 mm	829110	OL24	24 mm



### ////// Plaque de nylon armé / Reinforced nylon plate

Pour emporte-pièce. Modèle très dur pour la coupe des tissus. Dimension : 350 x 350 mm. Epaisseur : 50 mm.

/ For sweeping. Model for cutting hard fabrics. Size: 350 x 350 m. Thickness: 50 mm

830010 Plaque nylon armé

↳ Consulter-nous pour des dimensions particulières de plaques.

/ Consult us for special sizes of plates

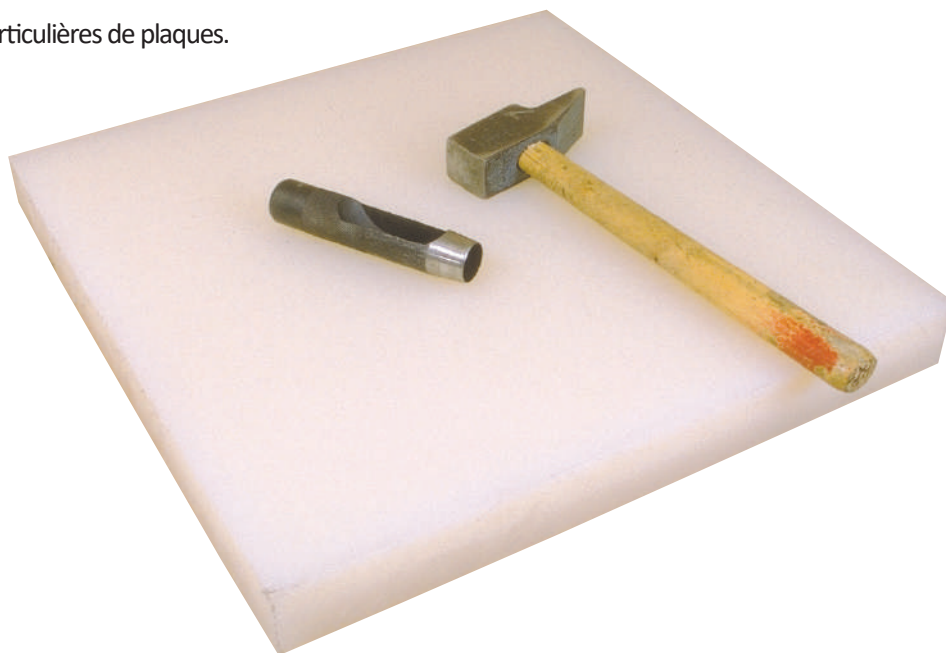

## Trousse de voilerie / Sail kit

### ////// Trousse voilerie standard / Standard sail kit

Dimensions : 160 x 220 x 45 mm.

Désignation	Quantité
Aiguille Voilier AV15	2
Aiguille Voilier AV16	2
Aiguille Voilier AV17	2
Bobine Fil poisse 1.5 mm	50 g
Fusettes de fil à voile 35 g	35 g
Paumelle droitier	1
Sangle largeur 30 mm	2 m
Bande droit-fil	2 m x 100 mm 260 gr

840500	Avec malette
840510	Sans malette



© Charles Drapeau / LP-vision

Trousse de voilerie / Sail kit

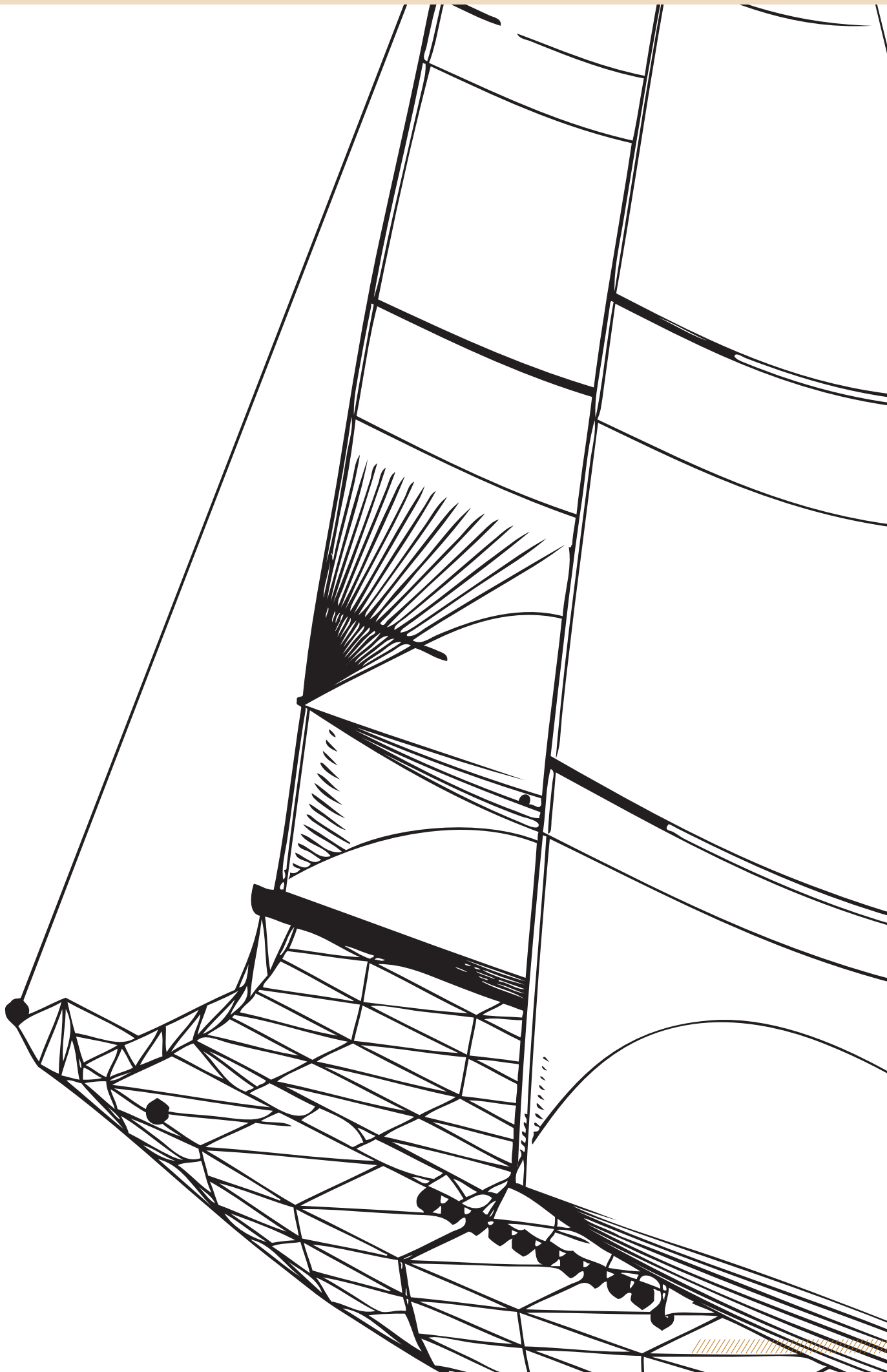

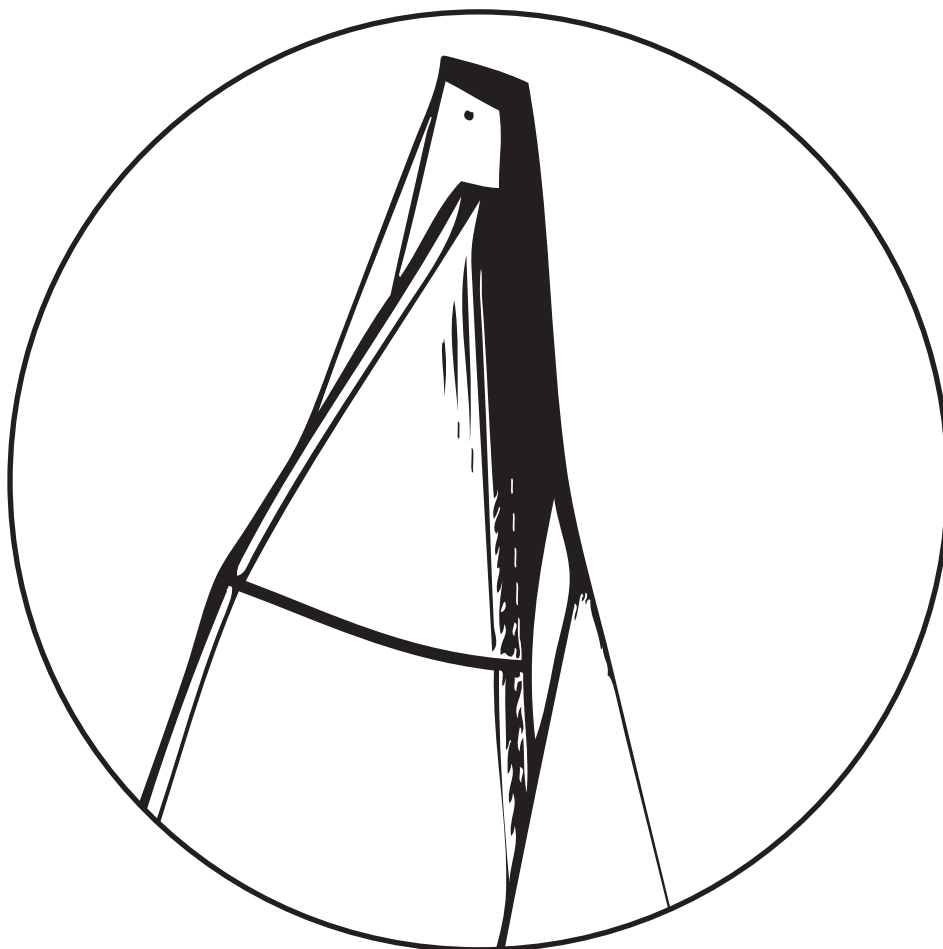

## Fiches techniques / *Data sheets*

Photos et couleurs de cette rubrique non contractuelles. Côtes et schémas peuvent être modifiés sans avertissement préalable.

*/ Pictures and colors are not contractual. Coasts and patterns can be changed without notice*

## Fiche de commande - Génois et Génois avec enrouleur

/ Order sheet - Genoa and Genoa with furling system

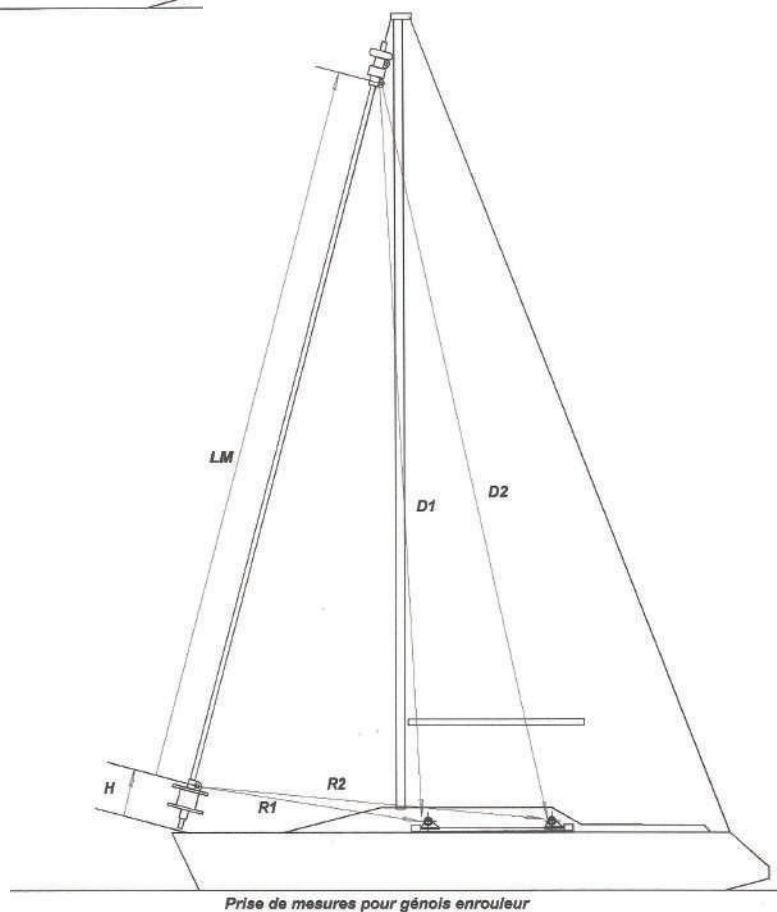
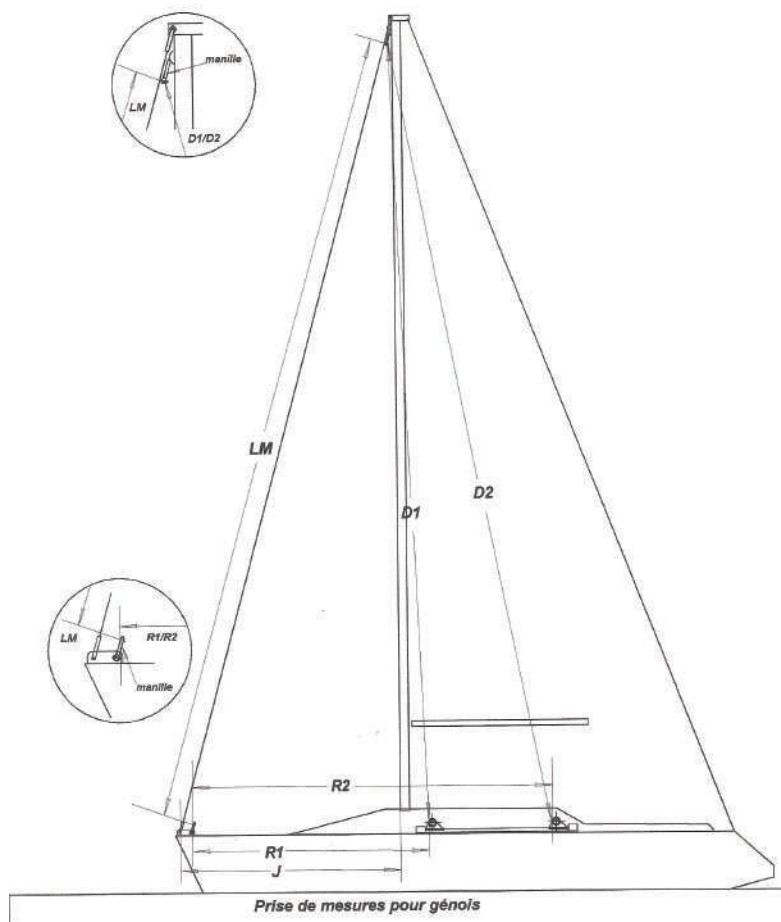

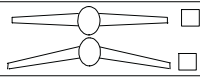

VOILERIE  **CONCEPTION**  N° DESSIN   
 E-MAIL  **GENOIS** date   
 Tel:  BATEAU  Longueur

type Gréement Tête  7/8  9/10  mat raide  mat Souple  droit  cintré   
 Etai: Cable  etais creux  Enrouleur  Etais largable  Anti-torsion  Nb barres de flèche    
 type de voile Genois: Leger  Medium  Lourd  Enrouleur  Inter  Solent  Foc II  Jauge HN  IRC  ORC   
 TMT  Trinquette  Reacher  Yankee  Autre:  Autre (ou règle de classe)   
 Usage Course croisière  Grandre croisière  Croisière côtière  Club regate  Regate  Economique   
 Plan de coupe Cross-cut  "Anglaise"  Mixte  Triradiale  Biradiale  Nb jonction horizontale 1  2  3   
 Surface  m<sup>2</sup> Guindant coupe  m matériau 1  Largeur tissu  m  
 LPG  m (ou) bordure coupe  m matériau 2  Recouvrement  mm  
 Têtière  m Chute coupe  m matériau 3   
 Détails: Nb lattes  (verticale)  Ris  Nb BV  Bande UV  Ourlet  mm Marques d'enroulements

Renforts: (type) Quadrangulaire  Elliptique  (composition) Multicouche  Etoile  Radial  Radial + multicouche  Pattes d'Oie  (classique)

I	J	Remarque:
LM	H	
R1	R2	
D1	D2	

SAIL LOFT  **GENOA**  N° design   
 E-MAIL  **DESIGN** date   
 Phone:  Boat  LOA

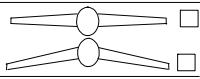
Rig Type mast head  7/8  9/10  Stiff mast  soft mast  straight  bend  Spreaders Nb:    
 Forestay Cable  tuff-luff  Furling system  removable forestay  Anti-twist luff rope   
 SAIL type: Genoa Light  Medium  Heavy  Furling  Genoa #2  Genoa #3  JIB ORC  Measurement Rules IRC  ORC   
 Storm Jib  Stay Sail  Yankee  Reacher  Other:  Other (class rule)   
 Use: offshore-racing  Offshore cruising  Coastal cruising  Club race  top race  eco   
 Panel lay out Cross-cut  Miter Cut  Vertical  Triradial  Bi-radial  Nb section seam 1  2  3   
 Sail area  m<sup>2</sup> Luff (finished)  m Sailcloth 1  Cloth width  m  
 LPG  m (or) Foot (finished)  m Sailcloth 2  Seam width  mm  
 Head  m Leech (finished)  m Sailcloth 3   
 Détails: Batten Nb  Vertical batten  Reef Nb  Speed stripes Nb  UV stripe  Fold over  mm furling marks

Patches (type) Quadrangular  Elliptic  (composition) Multilayer  Spider  Radial  Radial + Layers  Finger Patch  (classic)

I	J	Remarks:
LM	H	
R1	R2	
D1	D2	

## Fiche de commande - Grand voile et Grand voile avec enrouleur

/ Order sheet - Mainsail and Mainsail with furling system

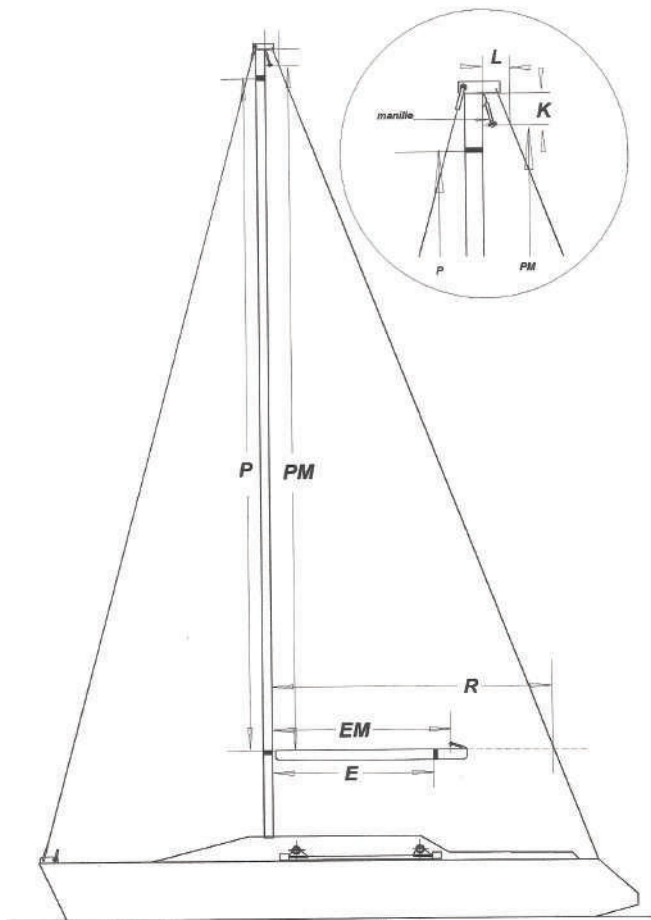

Prise de mesures pour grand-voile

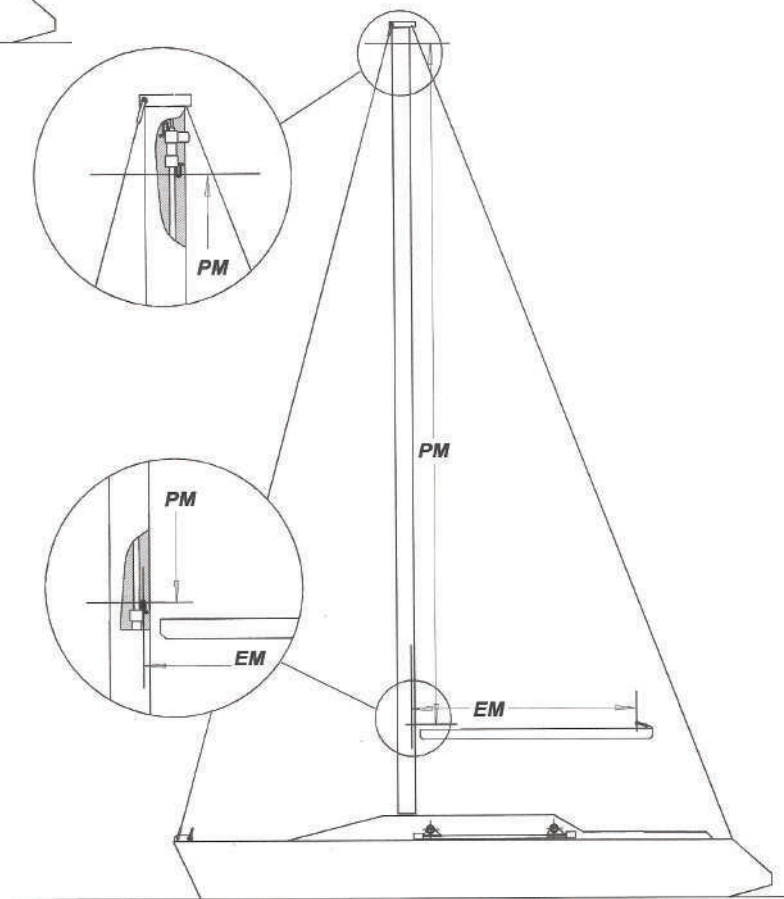

Prise de mesures pour grand-voile enrouleur

VOILERIE  **CONCEPTION** N° DESSIN   
 E-MAIL  **GRAND-VOILE** date   
 Tel:  **BATEAU**  Longueur

type Gréement Tête  7/8  9/10  mat raide  mat Souple  droit  cintré  Nb barres de flèche   
 ralingue  coulisseaux  chariots  bastaques  guignol  Enrouleur mat:  Enrouleur bôme:

type de voile classique  Lattes longue  full batten  multicoque croisière  Voile au Tiers  Jauge HN  IRC  ORC   
 deriveur  multicoque de sport  Voile de planche  voile de cape  Voile Aurique  Autre   
 (ou règle de classe)

Usage Course croisière  Grandre croisière  Croisière côtière  Club regate  Regate  Economique   
 Plan de coupe Cross-cut  Verticale  1/2 Laize  (option) Triradiale  Biradiale  Nb jonction horizontale 1  2  3

Surface <input type="text"/> m <sup>2</sup>	Guindant coupe <input type="text"/> m	materiau 1 <input type="text"/>	Largeur tissu <input type="text"/> m
Angle Bôme <input type="text"/> °	Chute coupe <input type="text"/> m	materiau 2 <input type="text"/>	
Tête <input type="text"/> m	bordure coupe <input type="text"/> m	materiau 3 <input type="text"/>	
		Recouvrement <input type="text"/> mm	

Details: Nb lattes  Nb latte forcée  Nb Ris  Nb BV  Cuningham  Ourlet  mm Marques d'enroulements

Renforts: (type) Quadrangulaire  Elliptique  (composition) Multicoque  Etoile  Radial  Radial + multicoque  Pattes d'Oie  (classique)

P	E	Remarque:	
PM	EM		
R	K	MGM	
L	HB	MGU	

SAIL LOFT  **MAINSAIL** N° design   
 E-MAIL  **DESIGN** date   
 Phone:  **Boat**  LOA

Rig Type mast head  7/8  9/10  Stiff mast  soft mast  straight  bent  Spreaders Nb:    
 Luff line  Sliders  Batten cars  runners  Diamond  Running backstay  Furling mast  Furling Bome

SAIL type: classic  "Long batten"  full batten  Cruising multihull  Gaff sail  Measurement Rules IRC  ORC   
 Dinghy  Sport Multihull  Surf sail  Trial Sail  Other:   
 (class rule)

Use: offshore-racing  Offshore cruising  Coastal cruising  Club race  top race  eco   
 Panel lay out Cross-cut  Vertical  1/2 panel  (option) Triradial  Bi-radial  Nb section seam 1  2  3

Sail area <input type="text"/> m <sup>2</sup>	Luff (finished) <input type="text"/> m	Sailcloth 1 <input type="text"/>	Cloth width <input type="text"/> m
Boom Angle <input type="text"/> °	Leech (finished) <input type="text"/> m	Sailcloth 2 <input type="text"/>	
Head <input type="text"/> m	Foot (finished) <input type="text"/> m	Sailcloth 3 <input type="text"/>	
		Seam width <input type="text"/> mm	

Details: Batten Nb  Full batten Nb  Reef Nb  Speed stripes Nb  Cuningham  Fold over  mm furling marks

Patches (type) Quadrangular  Elliptic  (composition) Multilayer  Spider  Radial  Radial + Layers  Finger Patch  (classic)

P	E	Remarks:	
PM	EM		
R	K	MGM	
L	HB	MGU	

## Fiche de commande - Spi symétrique et asymétrique

/ Order sheet - Symetric and Assymetric spinnaker

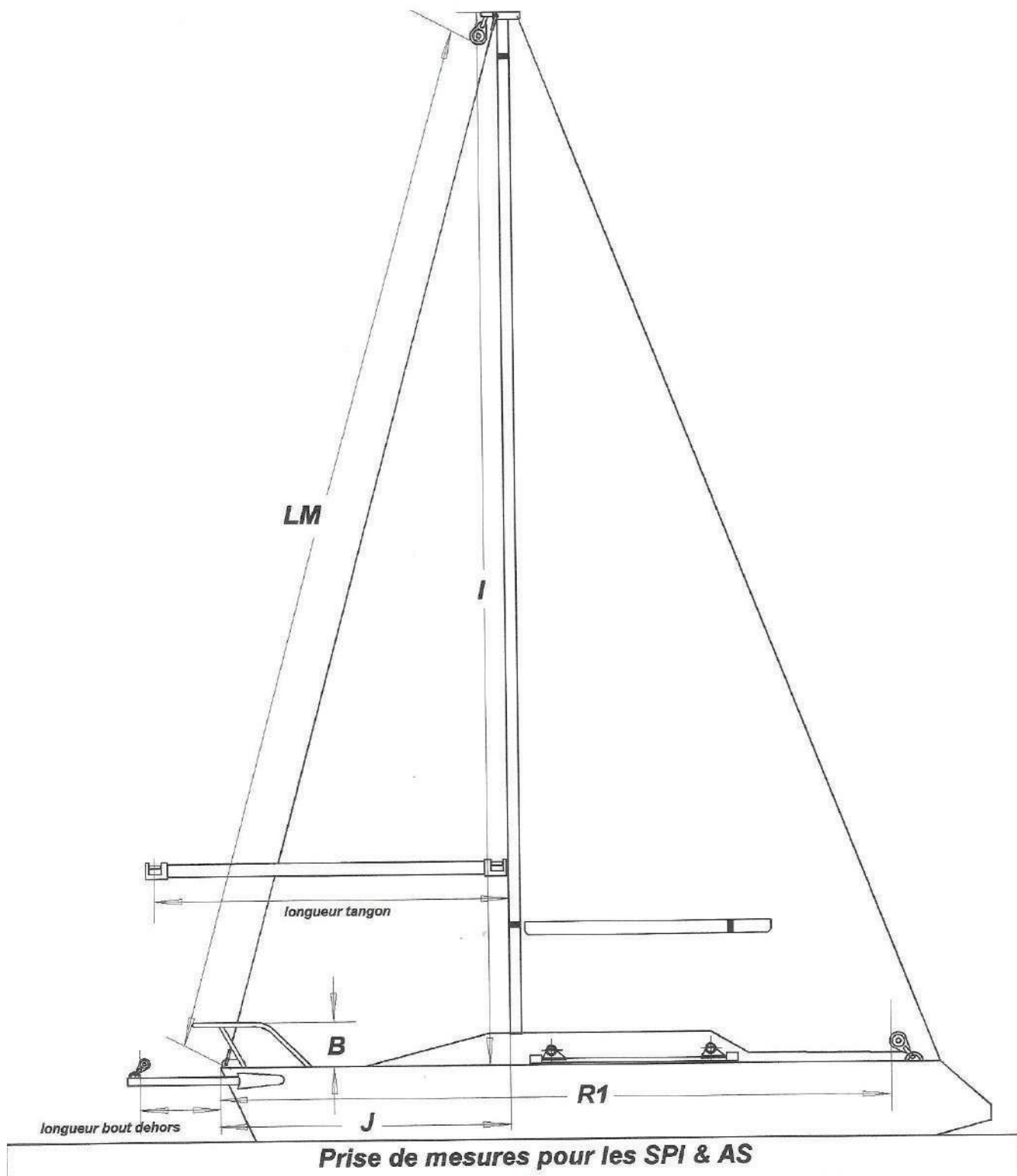

VOILERIE  **CONCEPTION**  N° DESSIN   
 E-MAIL  **SPI & ASY** date   
 Tel:  BATEAU  Longueur

type Gréement Tête  7/8  9/10  Tangon  Bout-dehors  Longueur  m Chaussette   
 type Bateau Croiseur  Deriveur  Multicoque croisière  Multicoque sport   
 SPI SYMETRIQUE Polyvalent  Vent Arrière  Largeur  Lourd  Leger  Jauge HN  IRC  ORC   
 SPI ASYMETRIQUE Polyvalent  Gennaker  Code 0  Autre (ou règle de classe)   
 Usage Course croisière  Grandre croisière  Croisière côtière  Club regate  Regate  Economique   
 Plan de coupe Triradial simple  Triradial Zone verticale  Horizontal  Biradial  Nb section milieu 1  2  3   
 Surface  m<sup>2</sup> SL1 (Guindant)  m matériau 1  Largeur tissu  m  
 SMG / SHW  m SF (bordue)  m matériau 2  Laize 1/1  Laize 1/2   
 SMW  m SL2 (Chute)  m matériau 3  Recouvrement  mm  
 Systeme d'enroulement Marque et type  Longueur du câble  m  
 Renforts: (type) Multicouche  Etoile  Radial  Radial + multicouche  Doublage laize

I	J	Remarque:
LM	B	
R1		
D1		

SAIL LOFT  **SPI & ASY**  N° design   
 E-MAIL  **DESIGN** date   
 Phone:  Boat  LOA

Rig Type mast head  7/8  9/10  Spinnaker Pool  Bow-sprit  Length  m Spinnaker sleeve   
 Boat type Cruiser  Dinghy  Cruising multihull  Sport multihull   
 SYMETRIQUE Allpurpose  Down wind  Reacher  Heavy  Light  Measurement Rules IRC  ORC   
 ASYMETRIQUE Allpurpose  Code 5  Code 0  Other (class rule)   
 Use: offshore-racing  Offshore cruising  Coastal cruising  Club race  top race  eco   
 Panel lay out Triradial  Triradial body section  Miter  Biradial  Nb Body section 1  2  3   
 Sail area  m<sup>2</sup> SL1 (Luff)  m Sailcloth 1  Cloth width  m  
 SMG/SHW  m SF (foot)  m Sailcloth 2  1/1 panel  1/2 panel   
 SMW  m SL2 (Leech)  m Sailcloth 3  Seam width  mm  
 Furling system Brand and type  Cable length  m  
 Patches Multilayer  Spider  Radial  Radial + Layers  panel double ply

I	J	Remarks:
LM	B	
R1		
D1		

**Fiche de commande - Voile d'ombrage** / Order sheet - Shade sail



**FICHE DE COMMANDE**

**VOILE D'OMBRAGE**

Votre tampon

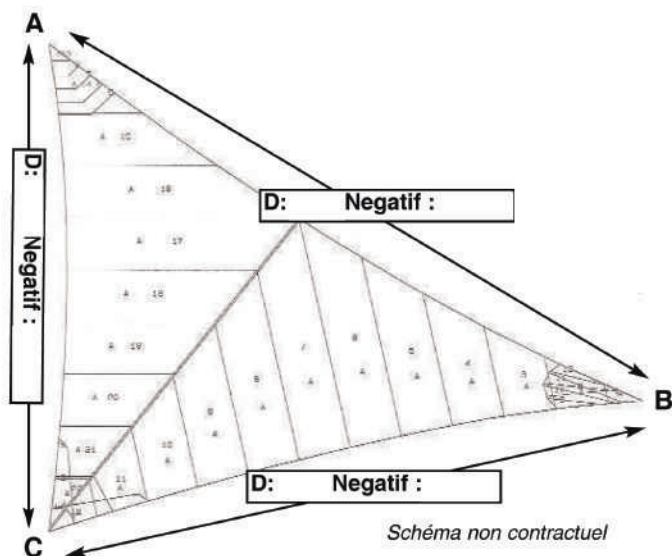

Nombre de cotés : 3 / 4

Valeur Recouvrement Coutures:

Tissus:  
Type:  
Largeur:

Renforts: OUI / NON  
Type: HEXAGONAL / DOIGT / ETOILE / 1/4 DE CERCLE

Type de coupe : CROSS CUT / ANGLAISE

Ourlet : OUI / NON Valeur :

Enrouleur : OUI / NON  
Entre quels points :

Fixation murale : OUI / NON  
Sur quels points :

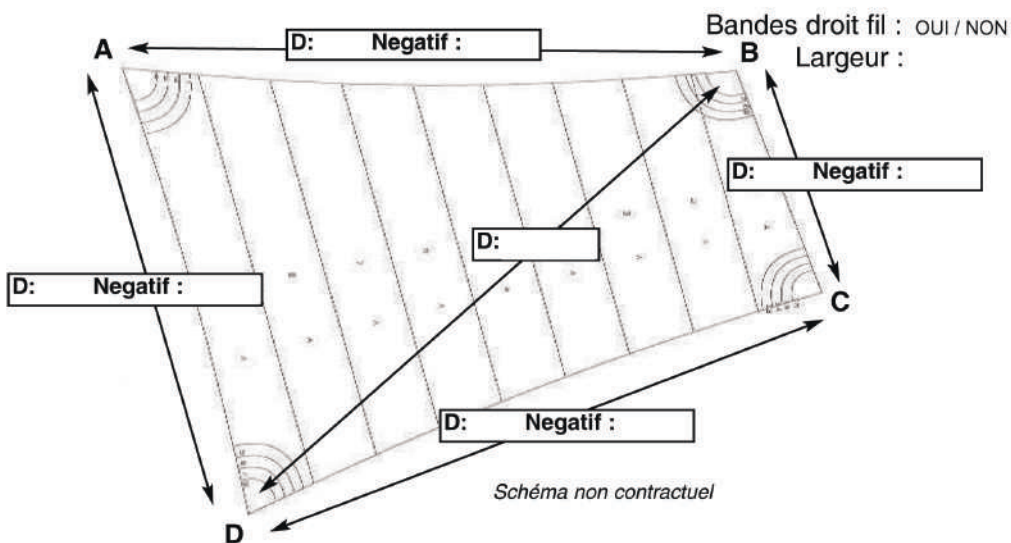

**Photocopie de cette fiche A REMPLIR et A NOUS RETOURNER**



VMG DECOUPE LASER

Rue Maurice Mallet - ZA de Beligon - 17300 Rochefort

Tél : 05 46 87 88 92 - Fax : 05 46 87 88 91

Email: laser-cutting@soromap.com

# NOTES

A series of 25 horizontal dashed lines for taking notes.

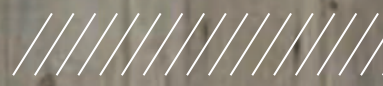





# Index / Index

Photos et couleurs de cette rubrique non contractuelles. Côtes et schémas peuvent être modifiés sans avertissement préalable.  
*/ Pictures and colors are not contractual. Coasts and patterns can be changed without notice*

**A**

Accessoires vaigrage / Ceiling accessories.....	p.81
Agrafeuse ROC 22 / Stapler.....	p.150
Agrafes ROC 22 / Staples.....	p.150
Agrafes galva / Galvanized Staples.....	p.118
Aiguille à long chas / Plastic bugs.....	p.161
Aiguilles à main / Hand needles.....	p.159
Aiguilles machine / Machine needles.....	p.159
Alène à vis / Awl screw.....	p.160
Alène manche plastique / Plastic handle awl.....	p.161
AMERICANA - MORBERN.....	p.64
Anneaux / Rings.....	p.124 -> 125
Anneaux Aluminium 6082T6 / Aluminum Rings 6082T6.....	p.127
Anneaux de voile inox 316L AQUABATTEN / Stainless steel - Sail rings.....	p.125
Anneaux inox 316L soudés BAINBRIDGE / BAINBRIDGE Stainless steel - Round rings.....	p.125
Anneaux inox 316L soudés barrés BAINBRIDGE / BAINBRIDGE Stainless steel - Maxi rings.....	p.125
Anneaux inox en D / D ring.....	p.124
Anneaux inox soudés barrés / Maxi rings.....	p.124
Anneaux ombrage / Shading rings.....	p.124
Anneaux plastiques / Plastic rings.....	p.134
Anneaux soudés inox 316L / 316L Round ring.....	p.124
ARCHI - SUNBRELLA.....	p.59
Arrêt haut inox YKK / YKK Stainless steel stop.....	p.145
Arrêts / Stops YKK / YKK Stops.....	p.145
Assortiment aiguilles / Assorted needles.....	p.159
Attache-rapide / Snap buckles.....	p.132
Auto agrippant à coudre / Velcro to sew.....	p.146
Auto-agrippant autocollant / Velcro sticker.....	p.146
Avaleurs polyester / Polyester bowl.....	p.157

**B**

Bandes droit-fil Nylon / Nylon Spinnaker Tape.....	p.94
Bandes de visualisation / Insignia tapes.....	p.87
Bandes droit-fil polyester haute tenacité / Polyester sailcloth tape.....	p.93
Bandes Dyneema® / Dyneema® Slit Tape.....	p.94
Bandes Téflon / PTFE Tape.....	p.94
Bandes UV, tauds, capotes, bimini,... / UV Stripes, Canopy, Sprayhood, biminis.....	p.24
BATYLINE ALPHALIA SILENT AW - SERGE FERRARI.....	p.74
BATYLINE DUO 7300, 7300 TWIST, 7300FR - SERGE F... ..	p.73
BATYLINE DUO 7300FR - SERGE FERRARI.....	p.59
BATYLINE EDEN 7710 - SERGE FERRARI.....	p.74
BATYLINE ELIOS 7740 - SERGE FERRARI.....	p.75
BATYLINE ISO 7406 - SERGE FERRARI.....	p.72
BATYLINE ISO 7407 - SERGE FERRARI.....	p.69 -> 70
BATYLINE ISO 7407FR - SERGE FERRARI.....	p.72
BATYLINE LOUNGE 7720FR - SERGE FERRARI.....	p.75
BAYSIDE - MORBERN.....	p.64
BENGALI - SUNBRELLA.....	p.49
Bloqueur cordon / Cord blocker.....	p.133
Boîtiers - Tendeur de latte / Case - Batten tension.....	p.153
Boîtiers de latte jonc chute / Leech batten rod cases.....	p.154
Boîtiers de latte jonc guindant / Luff batten rod cases.....	p.154
Boîtiers de latte plate / Batten plate cases.....	p.154
Boîtiers SDA / SDA fittings for Battens.....	p.153
Boucle inox / Stainless steel strap latch.....	p.131
Boucle sangle à coudre / Bolt buckle sewing.....	p.121
Boucles à came / Cam buckles.....	p.132
Boucles de réglage / Adjustable buckles.....	p.132
Boucles et attache rapide / Buckles and snap buckles.....	p.156
Boucles mixtes inox / plastique / Mixed buckle stainless steel / plastic.....	p.132
Boucles plastiques / Plastic buckles.....	p.132
Boucles sangle super / Super strap buckles.....	p.132

Boules plastiques / Plastic balls.....	p.134
Bouton de façage de taud / Button lacing.....	p.130
Bouton pression - Partie femelle / Button snap fasteners - Female part.....	p.135
Bouton pression - Partie mâle / Button snap fasteners - Male part.....	p.135
Bouton pression - Partie mâle Vis Parker / Button snap fasteners - Male screw part Parker.....	p.135
Bouton pression - Outil de pose / Button snap fasteners - Hand setting tools.....	p.106
Bright orange storm Dacron.....	p.13
Briquet / Lighter.....	p.162
Butées de latte BAINBRIDGE / BAINBRIDGE end fittings.....	p.150 & p.153
Butées de latte épaisse avec passage de sangle / Batten plate cases for webbing.....	p.152
Butées de latte plastique / Flat batten ends.....	p.152
Butées de latte plate avec passage de sangle / Flat batten ends for webbing.....	p.152
Butées plastique / Plastic stops.....	p.134

**C**

Câble anti-torsion / Antitorsion cable.....	p.108
Cardan inox articulé / Stainless steel toggle M10.....	p.113
CARRARA - MORBERN.....	p.67
Chariot «All Black» pour GV lattées / Stainless steel strit rod for reed batt.....	p.155
CHARTRES - SUNBRELLA.....	p.56
Chaussettes à spi VMG / VMG spinnaker socks.....	p.157
Chiffres et lettres découpés / Cut numbers and letters.....	p.89
Ciseaux tailleur «Fiskars» / «Fiskars» tailors scissors.....	p.161
Ciseaux universels «Fiskars» / «Fiskars» scissors.....	p.161
Ciseaux BAINBRIDGE / BAINBRIDGE scissors.....	p.161
Ciseaux Dyneema® / Dyneema® scissors.....	p.161
Clam à cheval / Horse clam.....	p.110
Clamcleat.....	p.117 -> 118
Clam suédois / Granssegel cleats.....	p.117
Clipper Canvas traité anti UV / UV resistant canvas clipper.....	p.20
Colle 3M Spray 77 / 3M 77 Spray adhesive.....	p.92
Colle Ferarri / Ferarri glue.....	p.92
Colle néoprène vaigrage / Inner hull glue for headline fabric.....	p.81
Colle vaigrage repositionnable phase aqueuse / Inner-hull adhesive repositionale aqueous phase.....	p.77
Colle voilerie / Sail glue.....	p.92
Colles / Glue.....	p.92
Colliers pour tube / Jaw slide for tube.....	p.129
Compte-fil / Wireless account.....	p.149
CONNECT réversible - SUNBRELLA.....	p.50
Connecteur de tube & clip / Tubing Hinge Quick Release.....	p.129
Connecteur lattes jonc BAINBRIDGE / BAINBRIDGE Batten connectors.....	p.155
Cordage 16 fuseaux polyester raide / Hard braid luff line 16 braids.....	p.107
Cordage Polyester 3 torons / Polyester 3 strands rope.....	p.107
Cordage Polypropylène 3 torons / Polypropylene 3 strands rope.....	p.107
Cordage pour guindant, Nerf de chute, Kitesurf / Ropes, Leech Line, Kitesurf.....	p.106 -> 107
Cosses cœur arrondies / Pods rounded heart.....	p.126
Cosses cœur barrées fonderie / Pods blocked heart foundry.....	p.126
Cosses cœur barrés inox 316L / Lugs welded to the heart barred gennaker.....	p.126
Cosses inox / Steel pods.....	p.121
Cosses inox Sailman / Sailman Steel pods.....	p.121
Coulisseau articulé / Articulated slide.....	p.113
Coulisseau avec boucle inox soudée / Slug Slides with Welded - Stainless Steel Bail.....	p.111

Coulisseau externe inox / External slides - stainless steel.....	p.111
Coulisseau faible friction / Allslip low friction slide.....	p.112
Coulisseau inox plat / Internal flat slides - stainless steel.....	p.112
Coulisseau inox SELDEN / SELDEN mast slides - stainless steel.....	p.112
Coulisseau intermédiaire / Slide through.....	p.113
Coulisseau interne aluminium / Internal slug slides - cast alloy.....	p.111
Coulisseau interne inox / Internal slug slides - stainless steel.....	p.111
Coulisseau moulé renforcé / Heavy duty slug slides with moulded in bail.....	p.111
Coulisseau plastique plat / Internal flat slides - plastic.....	p.112
Coulisseau plastique SELDEN / SELDEN mast slides - plastic.....	p.112
Coulisseau renforcé inox / Heavy duty slug slides - stainless steel.....	p.111
Coulisseaux / Slides.....	p.109 -> 113
Coulisseaux inox 316L / 316L stainless steel slides.....	p.109
Coulisseaux lubrifiés Full Batten / Lubricated slide Full Batten.....	p.113
Coulisseaux lubrifiés plats / Lubricated slides flat.....	p.109
Coulisseaux lubrifiés ronds / Lubricated slides round.....	p.109
Coulisseaux lubrifiés SELDEN / Lubricated slides SELDEN.....	p.110
Coulisseaux mixtes / Mixed slides.....	p.110
Coulisseaux nickelé / Nickel slides.....	p.110
Coulisseaux plastiques / Plastic slides.....	p.109 - 110 & 112
Coulisseaux pour rail / Slides rail.....	p.110
Coupe fil Wiss / Wiss wire cutter.....	p.162
Coupeur à chaud / Hot cutter.....	p.163
Coupeur à chaud sur batterie / Cordless heat cutter.....	p.163
Couronne à spi / Polyester bowl.....	p.157
Crayons / Pencils.....	p.163
Cristal classic : outdoor, industrie, UV, transparence / Cristal classic: outdoor, industry, uv, transparency.....	p.80
Cristal haut de gamme / Premium crystal.....	p.81
Cristal low Shrink.....	p.80
Cristal O'SEA® / O'SEA® Crystal.....	p.81
Cristal Regalite® / Regalite® Crystal.....	p.81
Cristal super : outdoor, marine, UV++ / Cristal super: Outdoor, marine, UV ++, extra transparent.....	p.80
Crochet de façage / Hook lacing.....	p.130
Crochet pneumatique gris / Grey inflatable hook.....	p.133
Crochet pour sandows 2 pièces Ø 6 & Ø 8 / Hook bungee cords to two parts Ø 6 & Ø 8.....	p.133
Crochets pour taud / Brackets for awning.....	p.133
Cuir de protection Traité Mer / Wed treated leather protection.....	p.160
Courseurs pour fermetures injectées / Sliders for injected closures.....	p.145
Courseurs pour fermetures spiralées / Sliders for injected closures.....	p.145

**D**

D CORE 78.....	p.103
D POWER.....	p.103
DACRON - VMG.....	p.29
Dacron 3.8 couleur / 3.8 colored Dacron.....	p.12
Dacron 6.03 couleur / 6.03 colored Dacron.....	p.12
Dacron autocollant / Dacron sticker.....	p.88
Dacron couleur 3.8 / Color Dacron 3.8.....	p.14
DEAUVE - SUNBRELLA.....	p.58
Découpe Seule / Only cut.....	p.6
Découvrit / Ripper.....	p.162
Dérouillant voile CLEANSAIL / Sail rust remover CLEANSAIL.....	p.158
Désagrafeuse / Staple remover.....	p.162
Dessin et découpe / Drawing and cutting.....	p.6
Disques crochet plastique / Crochet plastic discs.....	p.146
Disques velcro / Velcro discs.....	p.146

DOMINO - SUNBRELLA ..... p.60  
 Double décimètre / Double tape measure ..... p.163  
 Double face « Gripper » Spécial dralon  
 / Special double-sided gripper dralon ..... p.90  
 Double face acrylique classique  
 / Double-sided acrylic classic ..... p.90  
 Double face acrylique BAINBRIDGE  
 / BAINBRIDGE Double Sided Tape - Acrylic ..... p.91  
 Double-face Mylar/Kevlar® / Mylar/Kevlar® Seaming Tape . p.91  
 Double face SORO301 / Double-sided SORO301 ..... p.90  
 Double face TESA / Double-sided TESA ..... p.90  
 DROPS - SUNBRELLA ..... p.50  
 DUPIONE - SUNBRELLA ..... p.49

## E

EASY SAIL Tissus spi / EASY SAIL Race spi cloth ..... p.22  
 EDGE - MORBERN ..... p.71  
 Elastiques plats / Flat elastic ..... p.130  
 Elimeur « Fiskars » / « Fiskars » scissor tuner ..... p.162  
 Embout chute / Leech tip end ..... p.141  
 Embout guindant / Luff tip end ..... p.141  
 Embout guindant et chute / Luff & leech tip end ..... p.141  
 Embout tube Ø 25 avec vis de blocage  
 / Tube fitting Ø 25 with locking screw ..... p.118  
 Embouts basculants / Tipping tips ..... p.130  
 Embouts de latte / Batten fittings ..... p.155  
 Embouts de lattes jonc / Rod tip ends ..... p.151  
 Embouts latte jonc pour guindant ou chute  
 / Luff & leech round patten tip ends ..... p.151  
 Embouts lattes plates BAINBRIDGE  
 / Endcaps for flat battens ..... p.150  
 Embouts lashing / Lashing tips ..... p.155  
 Embouts latte jonc pour guindant ou chute  
 / Luff & leech round patten tip ends ..... p.141  
 Embouts pour tube / Eye end for tube ..... p.129  
 Embouts PVC guindant et chute  
 / PVC luff & leech tip ends ..... p.151  
 Embouts souples / Flexible tips ends ..... p.151  
 Emporte-pièce à arche / Hole punches ..... p.164  
 Emporte-pièce pour tourniquet  
 / Cutter & Setting for fasteners ..... p.136 & 140  
 Emporte-pièce simple / Single punch ..... p.164  
 Entretien machine à coudre  
 / Sewing machine maintenance ..... p.147  
 Epissoir inox / Stainless marlin spike ..... p.159

## F

FASNET High Mass Fiber Weave ..... p.11  
 Fermeture plastique continues YKK  
 / Plastic YKK continus zipper ..... p.144  
 Fermetures plastiques injectées séparables YKK10  
 / YKK10 Séparable injected plastic fasteners . . . p.142 & 143  
 Fermetures plastiques injectées séparables YKK5  
 / YKK5 Séparable injected plastic fasteners ..... p.142  
 Fermetures plastiques injectées séparables 15 mm curseur inox  
 / Plastic closures injected separable 15 mm stainless steel  
 sliders ..... p.144  
 Fermeur Fix / Regular socker ..... p.136  
 Fermeur Fix - Partie mâle à boulonner  
 / Stud with machine brass screw ..... p.136  
 Fermeur Fix - Partie mâle à vis  
 / Stud with stainless steel screw ..... p.136  
 Ferrures - Anneaux - Cosses / Fitting - Ring - Pods . p.132 & 133  
 Fil à surlier / Hand Sewing Thread & Wax ..... p.102  
 Fils Heminway & Bartlett Dabond  
 / Heminway & Bartlett Dabond thread ..... p.102  
 Fils Heminway & Bartlett Dabond Anti-Wick  
 / Heminway & Bartlett Anti-Wick NANO Bonded Thread . . p.102  
 Fil machine « Dabond » / Thread «Dabond» ..... p.103

Fil machine «Dabond» outdoor  
 / Outdoor «Dabond» thread ..... p.104  
 Fil machine tissé "San-Esu" Haute qualité  
 / Woven wire rod "San-Esu" High quality ..... p.103  
 Fil poisse pour finition / Waxed thread to finish ..... p.102  
 Filet de liaison / Net - Trampoline ..... p.49  
 Fils / Thread ..... p.102 & 104  
 Fixation de pont inox universelle à vis  
 / Stainless steel universal hinged deck mounts ..... p.117  
 Fixations et pression  
 / Rails & fittings bimini - hood ..... p.138 -> 141  
 FLEXLIGHT - SERGE FERRARI ..... p.40  
 FOUTHATHA - SUNBRELLA ..... p.61

## G

Galons et Bandes Nylon pour spi  
 / Braid and nylon tapes spinnaker ..... p.93  
 Garette nylon / Nylon lanyard ..... p.102  
 Genouillères / Knees ..... p.162  
 Grille fond de sac / Coussins ..... p.50  
 Gros crochet pour sandows  
 / Large hook for bungee cords ..... p.133

## H

HERITAGE - SUNBRELLA ..... p.58  
 HEXAGON - SUNBRELLA ..... p.54  
 High modulus dacron(R) 52 ..... p.10  
 HORIZON - SUNBRELLA ..... p.57  
 Huile de vaseline / Vaseline oil ..... p.159

## I

IKEBANA - SUNBRELLA ..... p.61  
 Insigna polyester 90 g/m<sup>2</sup> / Insigna polyester 90 g/m<sup>2</sup> . . p.154  
 Insigna BAINBRIDGE / Insigna BAINBRIDGE ..... p.86  
 Insigna polyester imprimable / Insigna printable polyester . . p.86

## J

Jeu de pose tourniquet / Set of poses tourniquet . . p.135 & 140  
 Joints BAINBRIDGE / BAINBRIDGE Extreme Seals ..... p.128  
 Jonc PVC pour ralingue / PVC band for luff tape ..... p.96

## K

KANOKO - SUNBRELLA ..... p.56  
 Kevlar® autocollant BAINBRIDGE  
 / BAINBRIDGE self-adhesive kevlar® patch ..... p.88  
 Kevlar® autocollant CHALLENGE / PSA Aramid ..... p.88  
 Kit de nettoyage et de réimpermeabilisation  
 / Kit of cleaning and waterproofing ..... p.158  
 Kit cross cut inshore ..... p.6  
 Kit cross cut OFFshore ..... p.6  
 Kit Laminés / Laminated kits ..... p.8  
 Kit orientés / Oriented sail kit ..... p.7  
 Kit spi / Spi kit ..... p.8  
 KITE LINE 12 - 99 ..... p.103  
 KITE LINE 8 - 78 ..... p.103  
 KITE LINE 8 - 99 ..... p.103  
 KITE LINE SKINCOVER ..... p.103  
 KIXX - MORBERN ..... p.69  
 KOMO - SUNBRELLA ..... p.59

## L

Lattes jonc vinylester / Rod vinylester battens ..... p.147  
 Lattes plates vinylester / Flat vinylester battens . p.147 & 148  
 Lattes plates SAILMAN / Pultruded flat battens ..... p.148  
 Lattes jonc SAILMAN / Pultruded rod battens roll ..... p.148  
 Lattes plates vinylester SAILMAN  
 / SAILMAN Flat vinylester battens ..... p.148  
 LINEN - SUNBRELLA ..... p.46

Liserets Blanc et Couleurs  
 / White and colours edging tape ..... p.93  
 LOPI - SUNBRELLA ..... p.57  
 LOXX - Bouton pression partie femelle ..... p.139  
 LOXX - Bouton pression partie mâle ..... p.139  
 LOXX - Clé manche bois pour Loxx ..... p.138  
 LOXX - Petite clé pour Loxx ..... p.138

## M

Machine à poser les œillets et œillets auto-perçant  
 / Eyelet machine and eyelets self-drilling ..... p.114  
 MAJESTIC - SUNBRELLA ..... p.59  
 Manchon inox pour latte jonc  
 / Stainless steel jonction for rod batten ..... p.155  
 Manchons colligo anti-torsion  
 / Antitorsion colligo sleeves ..... p.108  
 Manille plastique à visser / Screw-on shackles - plastic . p.114  
 Manille plastique noire à visser longue  
 / Long reach screw-on shackles ..... p.114  
 Manille inox à visser / Screw shackles - stainless steel . . p.114  
 Manilles / Shackles ..... p.114 & 153  
 Manilles à frapper / Snap-in shackles ..... p.114  
 Manilles à vis / Screw on shackles ..... p.114  
 MARBLE - SUNBRELLA ..... p.49  
 MARQUETRY - SUNBRELLA ..... p.60  
 Matrice pour cosse tête / Matrix to lug headboard . . p.121  
 MEZZO - SUNBRELLA ..... p.60  
 Minax / Minax ..... p.136  
 Monofilm autocollant / Monofilm sticker ..... p.23  
 Monofilm adhésive / Monofilm psa ..... p.23  
 Monofilm standard / Monofilm standard ..... p.23  
 MOSAÏC - SUNBRELLA ..... p.57  
 Mousqueton inox à émerillon  
 / Stainless steel swivel eye snap ..... p.131  
 Mousqueton inox à passage de sangle  
 / Stainless steel swivel snap hook for webbing ..... p.131  
 Mousqueton pompier inox ..... p.116  
 Mousqueton rapide en aluminium (attache jumelle)  
 / Sister clips ..... p.116  
 Mousquetons / Hanks & Snaps ..... p.115 & 116  
 Mousquetons bronze à frapper / Bronze jib hanks . . . p.115  
 Mousquetons inox à frapper / Stainless steel jib hanks . . p.116  
 Mousquetons inox à œil à sangler  
 / Stainless steel tack hook ..... p.116  
 Mousqueton laiton forgé suédois à pistons  
 / Swedish forged brass piston hanks ..... p.115  
 Mousquetons laiton à piston / Forged brass piston hanks . . p.115  
 Mousquetons laiton à piston à coudre  
 / Forged brass piston hanks sewing ..... p.115  
 Mousquetons plastique type 1/4 de tour pour foc  
 / Twist-on plastic jib hanks ..... p.116  
 Mousquetons plastiques / Plastic sail hanks ..... p.115  
 Mousquetons plastiques à visser  
 / Plastic piston jib hanks ..... p.116  
 Mousse à cellules fermées pour usage extérieur NSR3600  
 / Closed cell foam for outdoor use NSR3600 ..... p.152  
 Mousse à cellules ouverte pour usage extérieur TCL401  
 / Open cell foam for outdoor use TCL401 ..... p.152  
 Mousse de rattrapage de creux / Foam luff ..... p.92  
 Mousse haute résilience pour usage intérieur HR35040  
 / Highly resilient foam for indoor use HR35040 . . . . . p.152  
 Mousse haute résilience pour usage intérieur HR40060  
 / High resiliency foam for indoor use HR40060 ..... p.152  
 Mousse standard pour usage intérieur RP24043  
 / Standart foam for indoor use RP24043 ..... p.152  
 Mousse usage extérieur / Outdoor use foam ..... p.152  
 Mousse usage intérieur / Indoor use foam ..... p.152  
 Mylar Gabarit / Mylar template ..... p.23

**N**

NATTE - SUNBRELLA	p.55
NATURAL LINEN - MORBERN	p.68
Nerf de chute Kevlar® / Kevlar® leech	p.106
Nerf de chute polyester / Polyester drop line	p.106
Nerf de chute polyester pré-étiré / Leech polyester-tiré	p.106
Nerf de chute Spectra® / Spectra® leech line	p.106
Newport Strong fil – UV+	p.10

**O**

ODYSSEY	p.34
ODYSSEY FR	p.34
Œillets à bêche / Tarpaulin grommets	p.123
Œillets à griffe / Toothed grommets	p.123
Oeillets à griffe Stimpson	
/ Stimpson spur - Toothed grommets	p.123
Œillet attache-rapide "Holdon	
/ Eyelet tie fast "Holdon"	p.134
Œillet oval pour tourniquet	
/ Oval eyelet for tourniquet	p.135
Œillets «Endeavour» inox 316L	
/ «Endeavour» Stainless steel Grommets 316L	p.122
Œillets renforcés BAINBRIDGE & cosses	
/ BAINBRIDGE Inox Pressed Rings	p.123
Œillets SAILMAN / SAILMAN Rings	p.122
ORCHESTRA - DICKSON	p.26 -> 29
Outil de pose / Setting tool	p.121 & 135
Outillage / Tools	p.154
Outillage et entretien / Tools and maintenance	p.146 -> 150

**P**

Pack Performance / Performance kit	p.7
Pack Spi / Spi kit	p.7
Pack Standard / Standard kit	p.7
PALAZZO - SUNBRELLA	p.53
Partie femelle MINAX/ MINAX Female part	p.125
Partie femelle TENAX	
/ TENAX standard pull top wilock washer	p.126
Partie mâle MINAX / MINAX Male part	p.125
Partie mâle à boulonner TENAX	
/ TENAX Male part to be bolted	p.126
Partie mâle à platine TENAX / TENAX - 2 screw stud	p.126
Partie mâle vis tole 1 TENAX	
/ TENAX sheet metal screws male part 1	p.126
Passant sangle inox	
/ Stainless steel webbing strap fitting	p.131
Passants sangle Nylon / Nylon webbing strap fitting	p.131
Paumelles BAINBRIDGE / BAINBRIDGE hinges	p.160
Paumelles modèle standard / Standard model hinges	p.160
Peinture vaigrage PVC / Lining PVC paint	p.81
Penon de laine / Penon wool	p.156
Pentex Laminés / Laminated Pentex	p.17
Petit crochet pour sandows	
/ Small hook for bungee cords	p.133
Pied de coupe SF / Foot cutting SF	p.163
Pince à sertir / Crimping tool	p.130
Pince à tissu / Cloth clamps	p.162
Plaque de nylon armé / Reinforced nylon plate	p.164
Plaque de sangle nylon / Nylon strap plate	p.134
Plaque point d'écoute alu anodisée grise	
/ Aluminium anodised clew board	p.120
Plaque point d'écoute alu anodisée Sailman	
/ Sailman anodised aluminium clew board	p.120
Platines / Canopy Deck fittings	p.129
Poids de coupe / Cutting weight	p.149
Polyan pour gabarit / Monofilm sticker	p.23
Polyester   Élasthan	p.84
Polyester cruising laminates	
/ Polyester cruising laminates	p.17

POLYPLAN 725 Sattler Pro-Tex	p.40
Poulie + anneaux inox / Sportsboat clew ring	p.127
Poulie à cordon / Cord pulley	p.127
Poulie point d'écoute Alu	
/ Aluminium Clewblock Sheave Outhaul	p.127
Poulies et anneaux à friction / Blocks and friction rings	p.116
PRÉCONTRAIT PROTECT - SERGE FERRARI	p.39
PRÉCONTRAIT 332 - SERGE FERRARI	p.50
PRÉCONTRAIT 362 - SERGE FERRARI	p.50
PRÉCONTRAIT 392 - SERGE FERRARI	p.51
PRÉCONTRAIT 492 - SERGE FERRARI	p.51
Pressions DOT	p.140
Pression plastique STAYPUT / STAYPUT plastic pressure	p.141
PRODIGY - MORBERN	p.66
Produit anti UV / Anti UV	p.158
Produit d'entretien PVC / PVC Care Products	p.158
Protecteur / Protector	p.114
Protection UV polyester	
/ UV protection polyester sailcloth	p.15
Punaises plastiques / Plastic bugs	p.161
Push pin / Push pin	p.148
Pvc cristal pour tauds, capotes, fenêtres	
/ Pvc crystal for awnings, hoods, windows	p.85
Pvc sur feutrine / PVC on felt	p.76

**Q**

...

**R**

Rail pour ralingue / Rope rail	p.128
Rail pour ralingue BAINBRIDGE / BAINBRIDGE Rope rail	p.128
Ralingue BAINBRIDGE / Rope sewn assembly	p.97
Ralingue «Eco» double cordon	
/ Eco double rope luff tape	p.95
Ralingue «Eco» soudée simple cordon	
/ «Eco» simple cord rope welded	p.95
Ralingue assemblée 1 cordon cousue	
/ Rope assembly - A cord sewn	p.96
Ralingue assemblée cousue / Rope sewn assembly	p.96
Ralingue double cousue «Premium»	
/ «Premium» Double stitched rope	p.96
Ralingue soudée double	
/ Double rope welded luff tape	p.95
Ralingues / Headline	p.95 -> 96
RASANT	p.101
REEF - SUNBRELLA	p.50
RELAX - SUNBRELLA	p.59
REPAR SPI / Nylon Repair Tape	p.89
ROBBEN - SUNBRELLA	p.54
Réglets inox / Reglets steel	p.163
Répare spi / Spinnaker repairs	p.154
Répare voile / Sail repair	p.154
Ridoirs bimini / Bimini turnbuckles	p.129
Rivets de tête / Rivet headboard	p.121
RUSH - SUNBRELLA	p.72

**S**

Sacs à voile / Sailbag	p.82 -> 83
SAND PIPER - MORBERN	p.66
Sandow - Boucles - Œillets à coudre	
/ Bungees - Buckles - Sewing eyelets	p.130 -> 134
Sandows / Bungees	p.130
Sangle de bordage acrylique / Acrylic strap curling	p.99
Sangle de bordage polyester / Polyester strap curling	p.99
Sangle Dyneema® / Dyneema® Webbing	p.100
Sangle polyester / Polyester webbing	p.100
Sangle polyester épaisse « plus »	
/ Heavy «plus» polyester webbing	p.98
Sangle polyester lourde / Heavy polyester webbing	p.98

Sangle polyester Pes légère	
/ Pes lightweight polyester webbing	p.98
Sangle polyester renforcée	
/ Toe Strap, Jackstay & Seatbelt Webbing	p.101
Sangle polyester résistante épaisse	
/ Heavy resistant polyester webbing	p.98
Sangle Polyester Tubulaire	
/ Tubular polyester webbing	p.100
Sangle polypropylène / ppp webbing	p.101
Sangle Spectra® / Spectra® webbing	p.97
Sangles / Webbing	p.98 -> 101
SANIBEL - MORBERN	p.70
SAVANE - SUNBRELLA	p.57
SERABOND	p.101
SERAFIL	p.100
SHELFOOT	p.15
SHOCK - MORBERN	p.71
SLING - SUNBRELLA	p.58
SOFTOUCH	p.35
SOLACRYL	p.24
SOLARTEX 300	p.35
SOLID & STRIPES - SUNBRELLA	p.52 -> 54
SOLTIS HARMONY 88 - SERGE FERRARI	p.46
SOLTIS HORIZON - SERGE FERRARI	p.43
SOLTIS LOUNGE 96 - SERGE FERRARI	p.45
SOLTIS OPAQUE B99 - SERGE FERRARI	p.46
SOLTIS PERFORM 92 - SERGE FERRARI	p.44
SOLTIS PROOF - SERGE FERRARI	p.41
SOLTIS TOUCH - SERGE FERRARI	p.42
SOLTIS VEOZIP - SERGE FERRARI	p.48
SOLTIS W96 PROOF - SERGE FERRARI	p.45
Sous-matelas anti-condensation	
/ Under mattress anti-condensation	p.76
Spinnaker nylon fabrics	p.21
Spray 720 / Spray 720	p.92
STAMOID EASY - SERGE FERRARI	p.36
STAMOID EDGE - SERGE FERRARI	p.38
STAMOID HEAVY COVER - SERGE FERRARI	p.36
STAMOID LIGHT - SERGE FERRARI	p.37
STAMOID SMART - SERGE FERRARI	p.38
STAMOID TOP - SERGE FERRARI	p.37
STAMSKIN ONE - SERGE FERRARI	p.59
STAMSKIN ONE ALLURE - SERGE FERRARI	p.60
STAMSKIN TOP F4340 - SERGE FERRARI	p.62
STAMSKIN TOP CLUB - SERGE FERRARI	p.63
STAMSKIN ZEN - SERGE FERRARI	p.64
SUNBRELLA «PLUS»	p.31
SUNBRELLA Coussins / Cushions in & out	p.46 -> 57
SUNDANCE MGX - MORBERN	p.65
SUNDRELLA - SUNBRELLA	p.30 -> 33
SUNSET (SUNTROPIC) - VMG	p.29
SUNWORKER - DICKSON	p.47
SURF - MORBERN	p.65
Système de fixation tissu/rigide robuste et esthétique	
/ Fastening system fabric / strong, rigid and aesthetic	p.135-140

**T**

TAPIS IN & OUT - DICKSON / In & Out Carpets	p.58
TENARA	p.100
TENAX	p.138
Tendeurs de latte / Flat small adjusters	p.154
Tendeurs de latte Hollow / Hollow Batten tension	p.155
TERRY - SUNBRELLA	p.53
Tête aluminium évidée	
/ Aluminium hollow headboard	p.119
Tête composite VMG / Headboard composite VMG	p.119
Tête plastique / Plastic headboard	p.119 -> 120
Têtes / Headboard	p.119 & 120
Tissu à sac CORDURA 1000 D	
/ 1000 D CORDURA sailbag cloth	p.78

Tissu à sac standard nylon enduit PU 420 D  
/ 420 D Sailbag cloth coated ..... p.78

Tissu à sac lourd polyester enduit PU 600 D  
/ 600 D Sailbag cloth coated ..... p.78

Tissu à sac PE 14x14 MESH / Sailbag cloth Mesh ..... p.78

Tissu à sac recyclé polyester 450 D  
/ 450 D Recycled Sailbag cloth coated ..... p.79

Tissus classique Clipper Canvas traité anti UV  
/ UV resistant Canvas Clipper ..... p.20

Tissu Dacron Newport / Newport Dacron fabric ... p.12 & 13

Tissu Dacron Marblehead / Marblehead Dacron fabric ... p.14

Tissu Dacron Warp Drive / Warp Drive Dacron fabric ... p.15

Tissu Dacron Fastnet / Fastnet Dacron fabrics ..... p.15

Tissu de portant Baltic / Baltic Downwind sail cloth ... p.17

Tissu de portant Code-Tec / Code-Tec Downwind sail cloth ... p.17

Tissu de portant Sun-Tec / Sun-Tec Downwind sail cloth ... p.17

Tissu de portant CL Palma / CL Palma Downwind sail cloth ... p.17

Tissu Laminé XRP Sport / XRP Sport Laminated fabric ... p.16

Tissu Laminé XRP CL / XRP CL Laminated fabric ..... p.16

Tissu Laminé Palma-Tec / Palma-Tec Laminated fabric ... p.16

Tissu kevlar autocollant / Kevlar fabric sticker ..... p.89

Tissus mailles bloquées polyester  
/ Polyester mesh fabric blocked ..... p.79

Tissu polyester autocollant Insigna  
/ Polyester sticker Insigna ..... p.86

Tissu Spi AIRX Spi Regate / AIRX Spi Regate Race spi cloth ... p.22

Tissu tissé SPX / SPX Woven Fabrics ..... p.18

Tissu tissé SPX Classic / SPX Classic Woven Fabric ..... p.18

Tissu tissé SPX Black / SPX Black Woven Fabric ..... p.18

Tissu tissé SPX Storm / SPX Storm Woven Fabric ..... p.18

Tissu tissé SPX Colors / SPX Colors Woven Fabric ..... p.19

Tissu tissé HSX-P / HSX-P Woven Fabric ..... p.19

Tissu tissé HSX-V / HSX-V Woven Fabric ..... p.19

Tissus à sac / Bag fabrics ..... p.82 & 83

Tissus élastique ..... p.84

Tissus et bandes « FURLING » - SUNBRELLA  
/ SUNBRELLA - FABRICS AND TAPES "FURLING" ..... p.28

TISSUS MAILLE / Bag fabrics ..... p.84

Tissus Nylon « FIBERMAX » imprégné / Nylon fabric  
« FIBERMAX » impregnated ..... p.21

Tissus nylon « Elite » - Enduit  
/ Nylon fabric « Elite » coated ..... p.20

Tissus Polyester / Polyester Fabrics ..... p.30 & 31

Tissus techniques / Sailcloth ..... p.78 -> 81

Toile PVC enduite / PVC coated fabric ..... p.35 -> 37

TOP NOTCH 9 ..... p.35

TOUCH - MORBERN ..... p.67

Tourniquet / Turnbuckle ..... p.124-125 & 128

Transfert 3M 9485 / Tranfer 3M 9485 ..... p.91

TRAIL réversible - SUNBRELLA ..... p.50

Triangle inox 316 / Stainless Steel 316 Triangle ..... p.124

Triangle inox barrés 316L  
/ 316L Stainless steel triangle with bar ..... p.124

Trousse voilerie standard / Standard sail kit ..... p.165

Tube carbone / Carbon tube ..... p.152

Tube d'aiguilles à épisser  
/ Stainless steel plicing set with hooks ..... p.159

TUNDRA - SUNBRELLA ..... p.53

## U

...

## V

Vaigrage sur feutrine / Coated polyester fabrics ..... p.76

VELUM - SUNBRELLA ..... p.56

Vis alu / Aluminum screws ..... p.143

Vis de compression SDA  
/ SDA batten fittings - Compression screws ..... p.153

Voiles d'ombrages / Shades sails ..... p.5

VOLANS - MORBERN ..... p.68

## W

Warp drive ..... p.10

WAVE - MORBERN ..... p.72

Window X Ply / Window X Ply ..... p.23

Window DIAX ..... p.23

Windsurf / Kite ..... p.103

WINDSURFING LINE ..... p.103

## X

...

## Y

YKK fermeture plastique séparable  
/ Plastic YKK open ended ..... p.142 -> 143

YKK SNAD ..... p.141

YKK SNAD flexible ..... p.141

## Z

ZORI - SUNBRELLA ..... p.61



# NOTES

A series of horizontal dashed lines for writing notes.





# OMBORAGE - DESIGN

PRODUITS DOMESTIQUES - QUALITÉS MARINES



] Garde-corps & Cables ]



] Mats alu ]



] Voile d'ombrage ]



] Accessoires ]

] [www.soromapindustry.fr](http://www.soromapindustry.fr) ]



Des marques du Groupe Soromap



ZI de Beligon - 1, Rue Maurice Mallet  
17300 Rochefort sur mer  
+ 33 (0)5 46 87 84 80

 [contact@vmgsoromap.com](mailto:contact@vmgsoromap.com)  
[www.vmgsoromap.com](http://www.vmgsoromap.com)